



Honda Robotic Lawnmower HRM3000



Owner's Manual

Original Instructions

Service & Support



Please refer to "5.Mii-monitor Preparation" how to install the Mii-monitor and setting of Bluetooth®.



Congratulations on your selection of a Honda Robotic Lawnmower. We are confident that you will enjoy the benefit of your Honda Robotic Lawnmower as we take great pride in creating the finest quality lawn care products.

We want to help you get the best results from your new robotic lawnmower and to operate it safely. This manual contains all the information on how to do that; please read it carefully.

Your Honda servicing dealer is dedicated to your satisfaction and will be pleased to answer your questions and concerns.

Honda Motor Co., Ltd. reserves the right to make changes at anytime without notice and without incurring any obligation.

No part of this publication may be reproduced without written permission.

This manual should be considered a permanent part of the robotic lawnmower and should remain with it if it is resold.

Pay special attention to statements preceded by the following words;

⚠ WARNING

Indicates a strong possibility of severe personal injury or death if instructions are not followed.

CAUTION:

Indicates a possibility of personal injury or equipment damage if instructions are not followed.

NOTE:

Gives helpful information.

If a problem should arise, or if you have any questions about the robotic lawnmower, consult an authorised Honda dealer.

Honda robotic lawnmowers are designed to give safe and dependable service if operated according to instructions.

⚠ WARNING

Operating a robotic lawnmower requires special attention to ensure the safety of the operator and the safety of others. Read and understand this Owner’s Manual before operating the robotic lawnmower; failure to do so could result in personal injury or equipment damage.

How to identify your machine

The model of your robotic lawnmower is indicated on its “Identification label” by a series of letters.

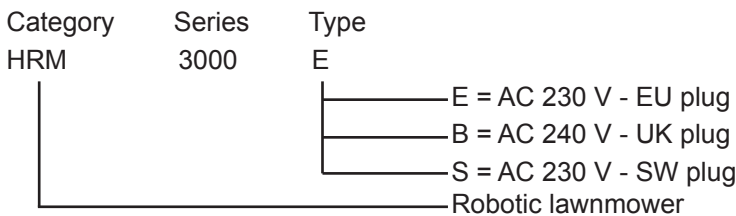

Make sure to have your dealer fill in “LAWN DIAGRAM” (☞ page 97) and “DEALER CHECKSHEET” (☞ page 100) with details on the installation it has performed and the settings it has configured.

- Apple, the Apple logo, and iPhone are trademarks of Apple Inc., registered in the U.S. and other countries. App Store is a service mark of Apple Inc.
- Google Play, the Google Play logo, and Android are trademarks or registered trademarks of Google Inc.
- *The Bluetooth®* word mark and logos are registered trademark owned by Bluetooth SIG, Inc. and any use of such marks by Honda Motor Co., Ltd. is under license. Other trademarks and trade names are those of their respective owners.

CONTENTS

Setting

Safety Instructions

Preparation

- Component identification (☞ page 10)
- Installation (☞ page 12)
- Setting up the lawnmower (☞ page 17)



Menu Settings

- Setting the work timer (☞ page 34)
- Setting the lawnmower operation (☞ page 38)
- Checking the system (☞ page 52)
- Viewing history (☞ page 55)
- Setting the system (☞ page 58)



Mii-monitor Preparation

(☞ page 62)



Operation

Usage

- Checking the mowing area (☞ page 66)
- Checking the lawnmower (☞ page 67)
- Turning on / off the power (☞ page 67)
- Operating the lawnmower in Auto mode (☞ page 69)
- Setting the height of the blades (☞ page 70)

Work (Auto)

According to settings, the lawnmower works automatically.

- Weekly checks (☞ page 72)
- Carrying the lawnmower (☞ page 73)

Troubleshooting

(☞ page 74)

Periodical Usage

Maintenance

- Periodic inspection and maintenance (☞ page 79)
- Maintenance procedures (☞ page 79)

Storage

(☞ page 88)

1 OVERVIEW	4
How the Honda Robotic Lawnmower works.....	4
2 SAFETY INSTRUCTIONS	6
Precautions	6
Label locations	9
Observe the following points for your safety	7
3 PREPARATION	10
Component identification.....	10
Setting up the lawnmower.....	17
Installation.....	12
4 MENU SETTINGS	32
Menu overview	32
Setting the work timer	34
• Work timer.....	34
• Seasonal timer.....	36
Setting the lawnmower operation.....	38
• Auto mode.....	38
• Garden layout	47
Checking the system.....	52
• Check signal	52
Viewing history	55
• Operation history	55
• Fault history	57
Setting the system.....	58
• Language.....	58
• Date and Time	59
• Reset	61
• Mowing start points	35
• Quiet timer.....	37
• Manual mode	45
• Homing setup	48
• Cutting height	50
• Test start points	53
• Work history	56
• Display/Sound	58
• Security	60
• Help.....	61
5 Mii-monitor Preparation	62
About Mii-monitor	62
Pairing a device (connecting via Bluetooth®).....	63
Installing Mii-monitor.....	62
Registering a user.....	64
6 USAGE	66
Checking the mowing area.....	66
Checking the lawnmower	67
Operating the lawnmower in Auto mode	69
Weekly checks	72
Connecting to a power source.....	66
Turning on / off the power	67
Setting the height of the blades	70
Carrying the lawnmower	73
7 TROUBLESHOOTING	74
Before contacting your dealer	74
Resolving problems.....	77
Messages	75
8 MAINTENANCE	79
Periodic inspection and maintenance	79
Maintenance procedures	79
9 STORAGE	88
Winter Storage	88
Get your lawnmower ready for the new season	88
10 TECHNICAL INFORMATION	89
Specifications	89
11 APPENDIX	90
Operating the lawnmower with the Manual mode	90
“EC Declaration of Conformity”	94
CONTENT OUTLINE	94
Major Honda Distributor Addresses	93
LCD MENU INDEX	96
LAWN DIAGRAM	97
DEALER CHECKSHEET	100
QUICK GUIDE	102

1 OVERVIEW

How the Honda Robotic Lawnmower works

The mowing area is determined by the boundary wire that emits a signal; when the lawnmower detects the boundary it turns and it cuts the grass randomly. When battery starts running out, it goes back to the docking station.

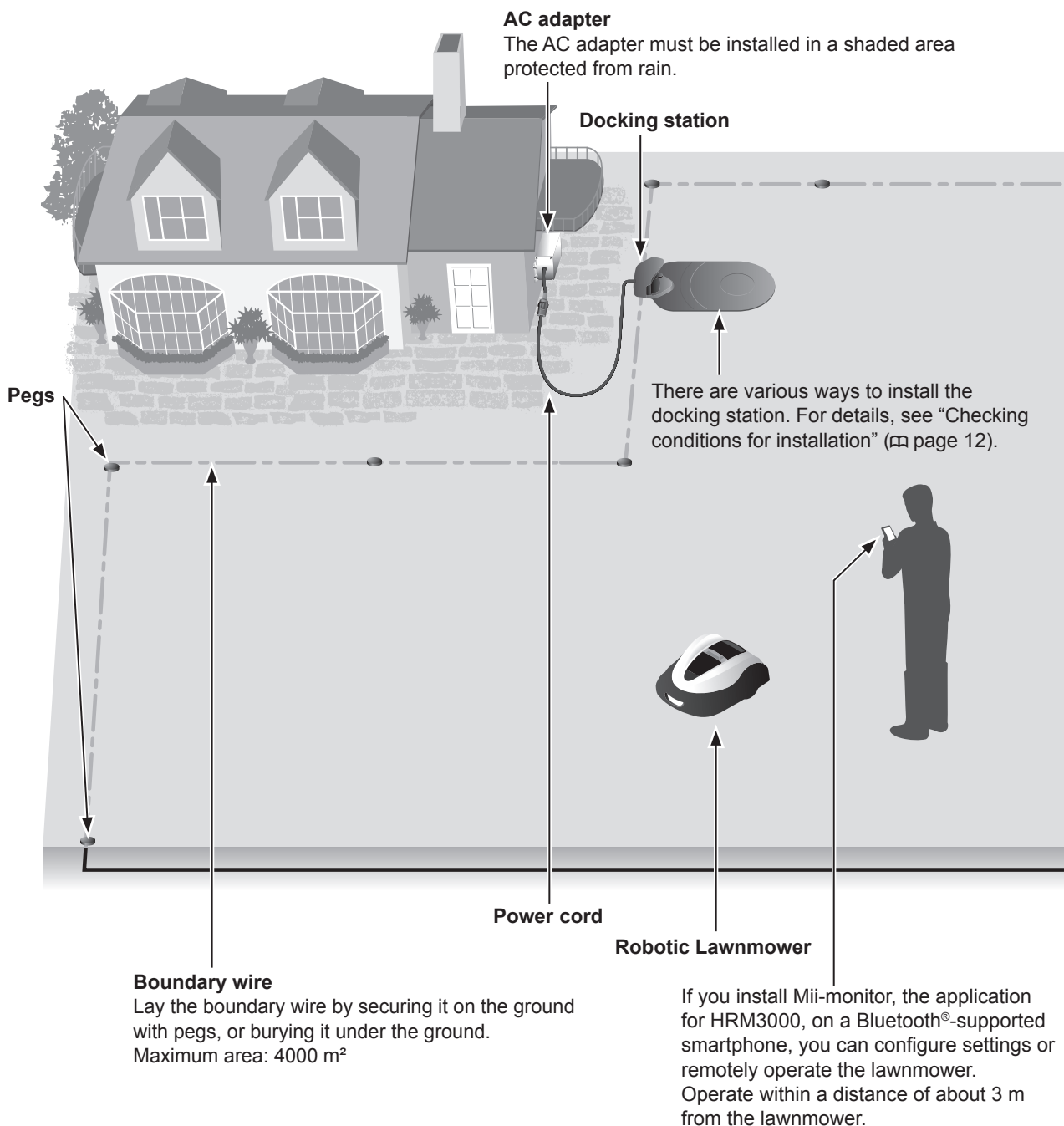

● Laying boundary wire

The boundary wire location determines the parameters of the mowing area, this area may consist of multiple sections in which the lawnmower can operate. For mowing start point setup and detailed information please see “4 MENU SETTINGS” (☞ page 32).

The work area must conform to the following conditions if it includes sloping areas.

Laying the boundary wire where the slope is too steep has a bad effect on the lawnmower. This is because the lawnmower follows along where the boundary wire has been laid.

- The lawnmower can operate on slopes of 25° (47%). Do not include slopes in the work area that are more than 25° (47%).
- Lay the boundary wire in locations that have a slope of less than 15° (27%).
- If the location in which you are laying the boundary wire has a slope that is steeper than 15° (27%), do the following.
 - Do not lay the boundary wire laterally across a slope that is steeper than 15° (27%).
 - Lay the boundary wire laterally across a relatively flat space, with a slope of less than 15° (27%), that comes after the location where the slope is more than 15° (27%). (Refer to the diagram below.)

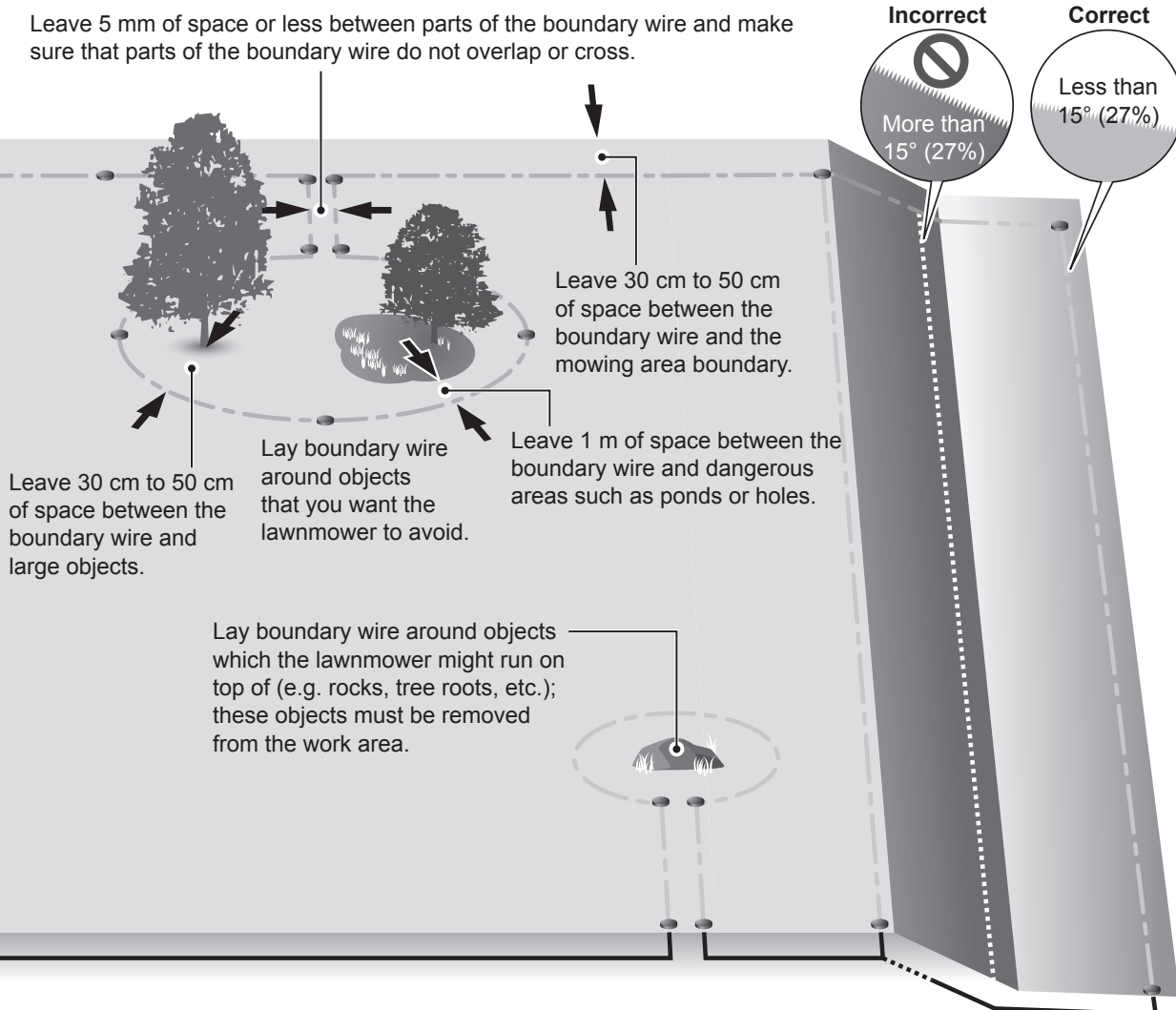

NOTE:

- Make sure to fill in “LAWN DIAGRAM” referring to the layout of boundary wire (☞ page 97).

2 SAFETY INSTRUCTIONS

Precautions

Carefully observe the following precautions.

- Make sure to keep your hands, feet and any other body parts away from the rotating blades.
- Do not touch sharp components such as the blades or blade disc other than when performing maintenance. If you do, you may be injured.
- Always press the manual STOP button first before you physically interact with the lawnmower such as lifting, turning sideways or upside down. If you do not, you may come in contact with the blades and become injured.
- Never allow children, persons with reduced physical, sensory or mental capabilities or lack of experience and knowledge or people unfamiliar with this owner's manual to use the lawnmower. Local regulations may restrict the age of the operator.
- Keep in mind that the operator or user is responsible for accidents or hazards occurring to other people or their property.
- Wear long pants and sturdy shoes when nearby or inside the work area while the lawnmower is operating.
- Before using the robotic lawnmower or entering the work area, persons using a pacemaker or other medical device should consult a doctor.
- Do not ride on the lawnmower, push the lawnmower, or use it for anything other than its intended purpose. An accident may occur or the lawnmower may be damaged.
- Never use the lawnmower in the immediate vicinity of people, especially children or pets.
- Carry out your mowing operation only within the boundary wire area.
- If there is a risk of the lawnmower damaged by contacting a sprinkler, move the sprinkler while the lawnmower is operating, or lay boundary wire around the sprinkler to remove it from the work area.
- If the outside air temperature is lower than 5°C, the lawnmower will be unable to charge. If lower than 0°C, the lawnmower will not charge nor operate.
- If there is a risk of adverse weather such as lightning or a storm, stop operation and disconnect the power cord.
- Parts of this product may become warm in direct sunlight. Make sure you do not touch these parts if they become extremely hot or you may burn yourself.
- Do not charge the lawnmower with anything other than the docking station. An accident may occur or the lawnmower may be damaged.
- If the power supply cord is damaged, immediately unplug it from the outlet and contact your dealer. Also, do not touch the damaged part of the power supply cord.
- If there are any holes (such as rabbit holes, etc.) in the work area, fill them in so that the work area is level. Periodically check the work area for holes.

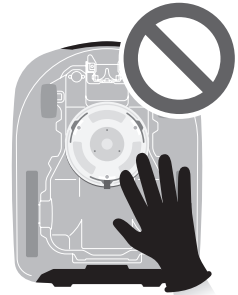

Observe the following points for your safety

- When carrying the lawnmower, turn it off and carry it as explained in this manual (see page 73) with the blades facing away from you.
- When carrying the lawnmower, make sure to carry it by the designated areas (see page 73). If you carry the lawnmower in any other way, you risk injury from the blades or charging socket of the lawnmower. You may also drop and damage the lawnmower.
- When using the remote control feature of the lawnmower application “Mii-monitor”, follow the precautions below.
 - Operate in a brightly-lit area
 - Avoid operating on wet grass
 - Thoroughly watch your footing on inclines
- Always use thick work gloves when performing maintenance. If you do not, you may be injured by the blades.
- Before operation, always check the work area and remove any branches, rocks, and other objects that can damage the blades and cause the lawnmower to stop. If you do not, you may be injured from objects that are ejected from the bottom of the lawnmower, or the lawnmower may become damaged.
- Always press the manual STOP button first before you physically interact with the lawnmower. If you do not, you may become injured, prevent the lawnmower from connecting to the docking station, or stop the lawnmower’s operation.
- When performing maintenance on the lawnmower, make sure to press the manual STOP button and stop the lawnmower from moving. If the lawnmower is moving, an accident may occur.
- Do not puncture, crush, short circuit the battery.
- Under normal conditions of use, the electrode materials and the electrolyte they contain are hermetically sealed, provided that the integrity of the battery is preserved and the solder remains intact.
- In case of opening of the vents or rupture of the containers, it can lead to an electrolyte leak.
- If inhaled, ventilate, rest and stay warm.
- In case of contact with the eyes, irrigate abundantly with water for at least 15 minutes.
- If swallowed, wash your mouth thoroughly and drink plenty.
- Warning: all the power circuits must be disconnected :
 - Before accessing to the terminals.
 - After hitting a foreign object to examine the damage to the machine.
 - In the event of accident.
 - Before any intervention on the machine.
- In case of person injury, all the power circuits must be disconnected. Call local emergency medical services.

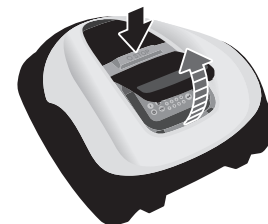
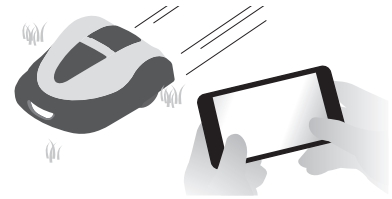

- Lay the boundary wire so that it is held firmly in place, and perform periodic checks after laying it to ensure that it has not slackened. If the boundary wire protrudes from the ground, you or someone else may trip on it and fall.
- Do not touch the exposed tip of a boundary wire that has been cut or damaged. You may be injured or electrocute yourself.
- If you find that the boundary wire has been cut, turn off the lawnmower, unplug the AC adapter's plug from the power outlet (House), and contact your dealer.
- Install the AC adapter in a place that is out of direct sunlight and does not get wet even in the rain.
- Wear gloves when touching the AC adapter because it becomes hot when it is plugged into a power outlet (house).
- Naked flame sources, such as candles, must not be placed on the AC adapter.
- The AC adapter and the mains-socket must all times be easily accessible.
- In case of broken cords or plugs the AC adapter must be disposed.
- The AC adapter does not require much attention. If you want to clean it, please use only dry cloths or brush.
- Use this AC adapter by children shall be under the full supervision of parents.

IP55 is applicable to the adaptor body except plug part. The plug part must be placed beneath the canopy. When outdoor use, plug part must be inserted into a waterproof socket.

IP degree of Plug:

ETX1HD940EAK ... IP44 for plug part

ETX1HD940BAK ... IP20 for plug part

EXT1HD940WAK ... IP20 for plug part

Note1: The adaptor body also pass the IP68 test.



Protection class II appliance



non-inherently Short-circuit-proof safety isolating transformer



Switch mode power supply unit

- Do not touch the charging socket. If you touch it, you may become injured.
- Observe the following points when touching the power outlet (House), power cord, and AC adapter. If you do not, you may be electrocuted.
 - Do not touch the power outlet (House), cord, and AC adapter with wet hands.
 - Do not touch the power outlet (House), cord, and AC adapter if the power outlet (House), power cord, or AC adapter is wet.
- Perform periodic checks to confirm that no dust, dirt, or other things have gathered in or on the power outlet (House), power cord, or AC adapter. If such things are present, remove them or they may cause a fire.
- When connecting the plug, hold the plug by its designated grip area. Failure to hold the plug correctly may result in electrocution if you touch the connector area.
- Make sure that the contents of "SAFETY INSTRUCTIONS" are absolutely clear to persons who may come in contact with the robotic lawnmower. If you do not, an accident may occur.
- People who are not thoroughly familiar with this Owner's Manual should not come into contact with the lawnmower other than to stop it.
- When approaching the operating lawnmower, pay attention to materials that may be scattered by the blades.
- Do not use the lawnmower if the outer casing is damaged.
The blade may accidentally cut you or you may be injured by debris thrown off by the blade.
- Never attempt to tamper with the lawnmower. It can cause an accident as well as damage to the lawnmower.

Disposal

To protect the environment, do not dispose of this product, battery, etc. carelessly by leaving them in the waste.

Observe the local laws and regulations or consult your authorised Honda dealer for disposal.

Label locations

● POSITIONING OF SAFETY LABELS

Your lawnmower should be used with due care and attention. Therefore, figured labels have been placed on various parts of the machine to remind you of the main precautions to be taken. Their full meaning is explained later on. These labels are an integral part of the lawnmower and so, if any of them should become detached or illegible, contact your servicing dealer for their replacement. You are also asked to carefully read the safety regulations in the applicable chapter of this handbook.



Bluetooth®

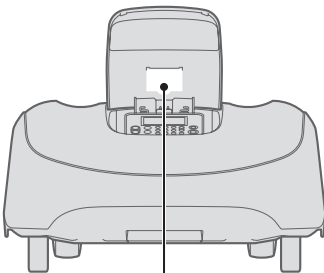
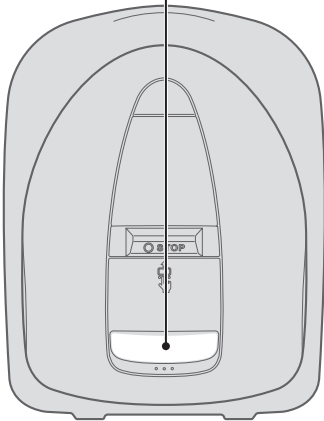





The Honda Robotic Lawnmower is designed to give safe and dependable service if operated according to instructions. Read and understand the Owner's Manual before operating the Honda Robotic Lawnmower. Failure to do so could result in personal injury or equipment damage.



Keep all persons and pets away from the Honda Robotic Lawnmower area.



Do not touch the rotating blade. Beware of sharp blades : blade in movement. Operate the disabling device before working on or lifting the machine.



Do not ride on the machine. This machine is not a toy, keep children away from the machine.

● POSITIONING OF CE MARK, SERIAL NUMBER, AND OTHER INFORMATION

The manufacturer's name and address, CE mark, serial number, and other information are in the following locations indicated in the illustration.

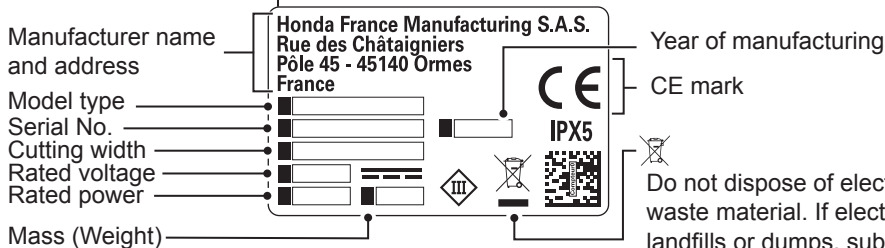

Do not dispose of electric equipment together with household waste material. If electrical appliances are disposed of in landfills or dumps, substances can leak and react and enter into the foodchain, damaging your health and well-being. For further information on the disposal of this product, please contact your dealer or your nearest domestic waste collection service.

3 PREPARATION

Component identification

● Body

Top view

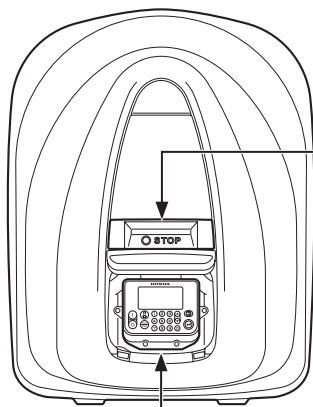

Manual STOP button
When you press the manual STOP button, the control panel cover pops up.

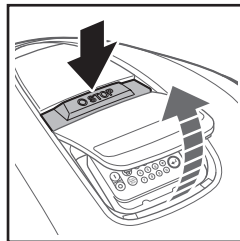

Control panel

Bottom view

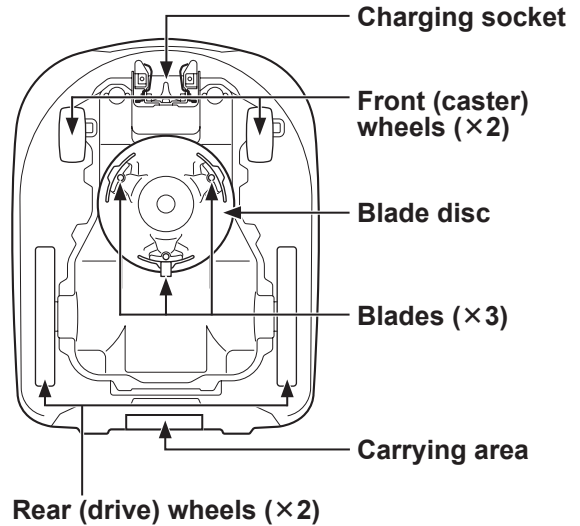

Charging socket

Front (caster) wheels (×2)

Blade disc

Blades (×3)

Carrying area

Rear (drive) wheels (×2)

● Docking station

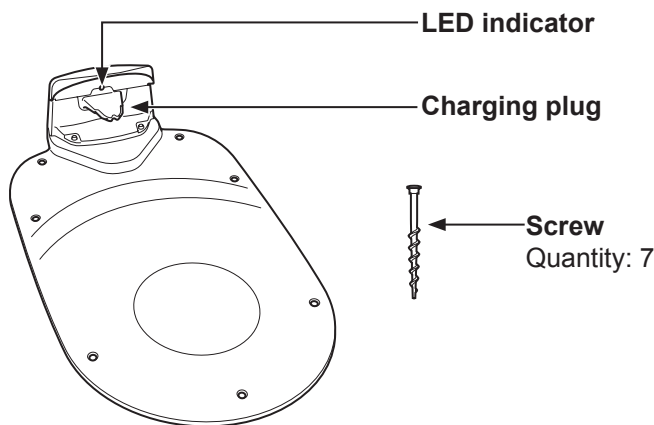

LED indicator

Charging plug

Screw
Quantity: 7

The lawnmower recharges at the docking station, and returns to the docking station when mowing is finished or the battery's charge becomes low. You can check the status of the boundary wire with the LED indicator (⌘ page 67).

● Supplied items

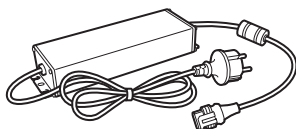

AC adapter

Install the AC adapter off the ground. After making all other connections, connect the AC adapter to the power outlet (House).

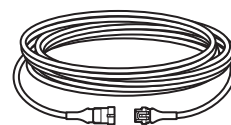

Extension cord

If the power cord of the AC adapter is not long enough, you can extend it with the extension cord. Length: 10 m

● Control panel

Display

The home screen and menus can be seen here while the lawnmower is turned on.

On button

Press to turn on the power.

Off button

Press to turn off the power.

NOTE:

- The timer does not function if you turn off the power.

Home button

Press to automatically return the lawnmower to the docking station after you close the control panel cover.

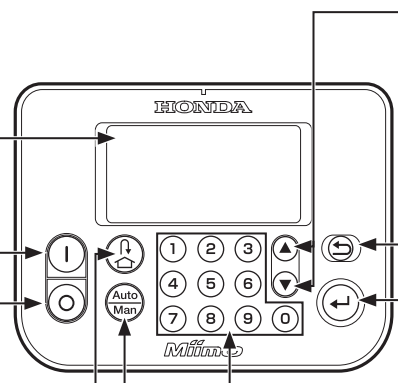

Up/down buttons

Press to navigate to the previous/next item in the display.

Back button

Press to return to the previous menu in the display. (The back button cannot be used in some cases.)

Enter button

Press to enter your selection in the display.

Number buttons

Press to enter numbers in the display menus. When there is a number to the left of a display menu item, you can press the corresponding number button to highlight that item.

Auto/Manual selection button

Press from the home screen to switch between operation modes. You can choose from Auto or Manual modes. For details, see "4 MENU SETTINGS" (☞ page 32).

● Home screen

Mode selection button on which Lawnmower setting status is displayed as below:

Icons	Description
	Auto mode is set.
	Manual mode is active and no timer is set.
	The lawnmower will return to the docking station.
	Auto height adjust
	Manual cutting height

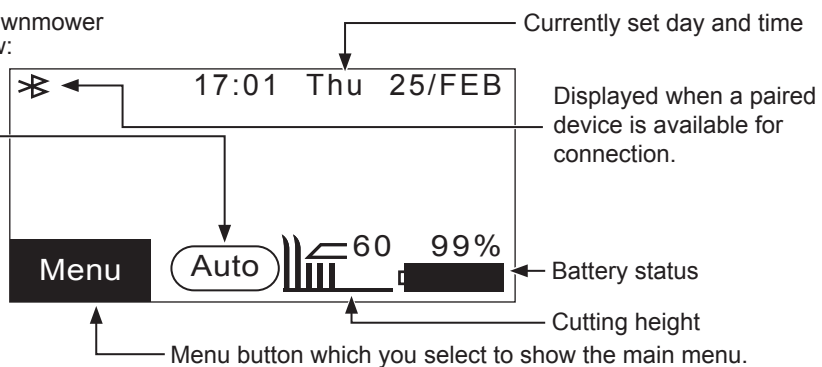

● Item selection screen

Name of the first level menu

Selectable menu items and current setting status.

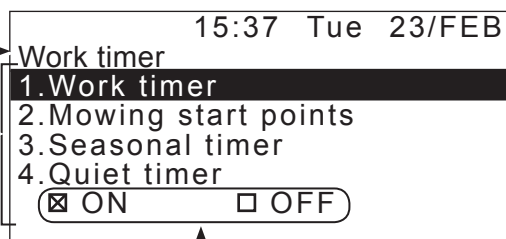

You can display the previous screen by pressing the ⏪ button.

Selectable boxes to which you add a check by pressing the ⏩ button.

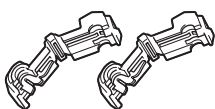

Connectors for the boundary wire

Use connectors to bind the boundary wire and connect it to the docking station.
Quantity: 2

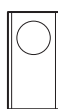

Spare Blades

Use spare blades to replace the worn ones.
Quantity: 9

Ruler

Part of the packaging of this product is a ruler. This ruler is used to check the position of the boundary wire installation.



Mii-monitor

Download from the App Store® or Google Play™. You can remotely operate the lawnmower. (☞ page 62)

Installation

We recommend that an authorised Honda dealer performs the installation of your Robotic Lawnmower.

Checking conditions for installation

Check with the dealer that performed the installation if the docking station and boundary wire are installed according to the conditions below. Also periodically confirm that these conditions are still met.

If any of these conditions are not met, consult your dealer.

It is recommended that the mains power supply is professionally installed in line with local laws and regulations.

Conditions for installing the docking station

Image	Condition
	<ul style="list-style-type: none"> • The docking station must be installed on a flat surface with an inclination of no more than 5° (8.7%). • The docking station must not be curved. • The screws must be firmly tightened. • Before installing the docking station, check the ground condition which may vary seasonally. It may be necessary to maintain the ground with the season. • If installing the docking station directly on the lawn, cut the grass on which the docking station will be located as short as possible. • Because of a wrong installation of the docking station, the lawnmower may not be charged.
	<p>Install the docking station in a place where there are no obstacles in the area indicated with the slanted line.</p>
<p>Docking direction</p> <div style="display: flex; justify-content: space-around;"> <div style="text-align: center;"> <p>Pattern 1</p>  </div> <div style="text-align: center;"> <p>Pattern 2</p>  </div> </div> <div style="display: flex; justify-content: space-around; margin-top: 10px;"> <div style="text-align: center;"> <p>Pattern 3</p>  </div> <div style="text-align: center;"> <p>Pattern 4</p>  </div> </div>	<p>Docking direction There are four patterns for installing the docking station.</p>

Image	Condition
Example of correct installation	
<p>Pattern 1</p> 	<p>Pattern 1: Standard installation Connect the docking station perpendicular to the wire.</p>
<p>Pattern 2 / Pattern 3</p> 	<p>Pattern 2: Clockwise installation Connect the docking station parallel to the wire (in the clockwise direction).</p> <p>Pattern 3: Counter-clockwise installation Connect the docking station parallel to the wire (in the counter-clockwise direction).</p>
<p>Pattern 4</p> 	<p>Pattern 4: Alcove installation Connect the docking station in an alcove.</p>
Example of incorrect installation	
<p>Example 1</p> 	<p>Example 1 Do not run the boundary wire underneath the docking station.</p>
<p>Example 2</p> 	<p>Example 2 Do not place obstacles beside the docking station. Obstacles must be separated from the wire by a distance of 30 cm or more.</p>
Example of narrow passage installation	
<p>Select Pattern 2 or Pattern 3 for the following example.</p> 	<p>Narrow passage installation</p> <ul style="list-style-type: none"> • A narrow passage is one in which the distance between wires is 3 m or less. • Do not make the distance between wires 1 m or less.
<p>Select Pattern 4 for the following example.</p> 	<p>NOTE:</p> <ul style="list-style-type: none"> - For narrow passage installations, do not select docking direction Pattern 1.

● Conditions for laying the boundary wire

Image	Condition
	<p>Lay boundary wire around objects which the lawnmower might run on top of (e.g. rocks, tree roots, etc.); these objects must be removed from the work area.</p>
	<p>The boundary wire entry and exit points for a round area should be separated by less than 5 mm. (However, the boundary wire should not cross itself.)</p>
	<p>There must be 30 cm to 50 cm of space between the boundary wire and large objects. (This space can be reduced to as low as 30 cm if you set [Wire Overlap] to a low value. For details, consult your dealer.)</p>
	<p>Lay fence around areas which the lawnmower might fall into, such as uneven ground, ponds, pools, driveways, or other areas with differences in height.</p>
	<p>Do not lay boundary wire so that it intersects on a slope of more than 15° (27%). You can lay boundary wire parallel to a slope of more than 15° (27%) in order to access an area with a slope of less than 15° (27%).</p>
	<p>Boundary wire should be laid so that there is no excess wire.</p>
	<p>The lawnmower can detect the signal from the boundary wire within a 20 m radius. If the lawnmower enters a space inside the work area with no boundary wire within a 20 m radius, the signal will not be detected and the lawnmower will stop. Maximum area: 4000 m²</p>
	<p>The boundary wire must not be laid with any acute angles. (Angles should be more than 90°.)</p>

Image	Condition
<p>More than 3 m</p> <p>More than 1 m</p> <p>Docking station</p> <p>Boundary wire</p> <p>Boundary wire of the another robotic lawnmower</p>	<p>If you want to use an additional robotic lawnmower, the boundary wire must be laid according to the figure on the left.</p>
<p>1 m or more</p>	<p>Narrow passage (distance between wires) should be more than 1 m.</p>

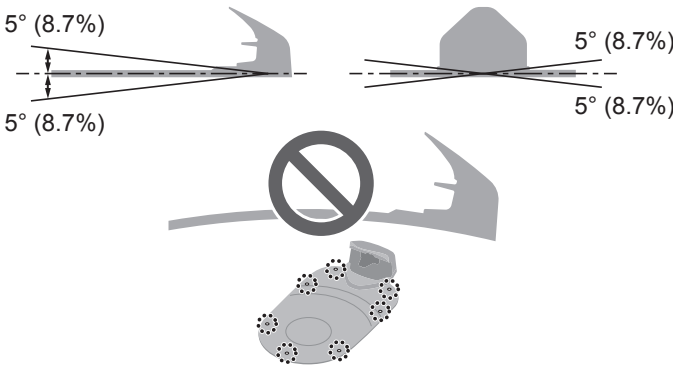
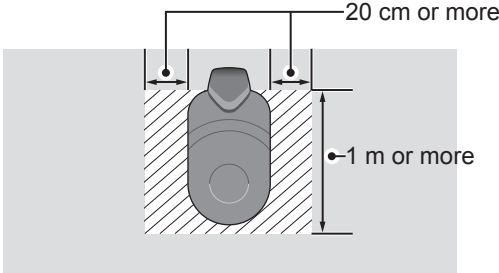
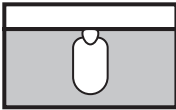
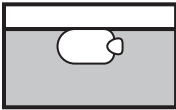
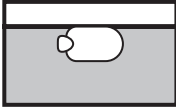
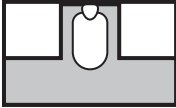
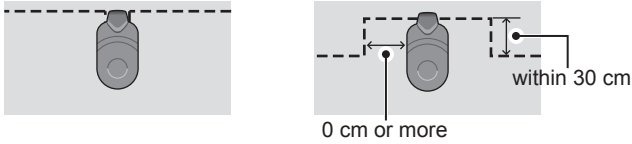
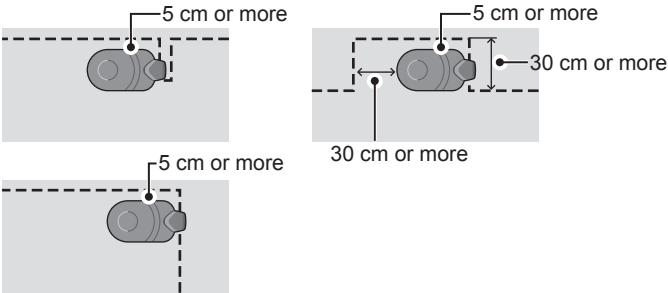
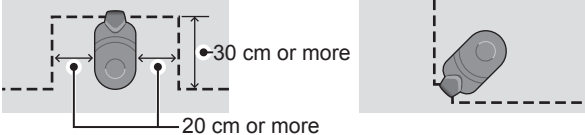
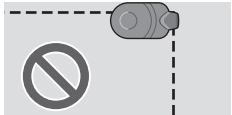
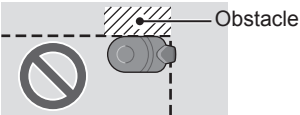
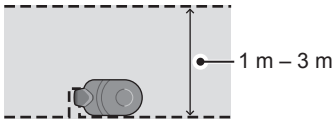
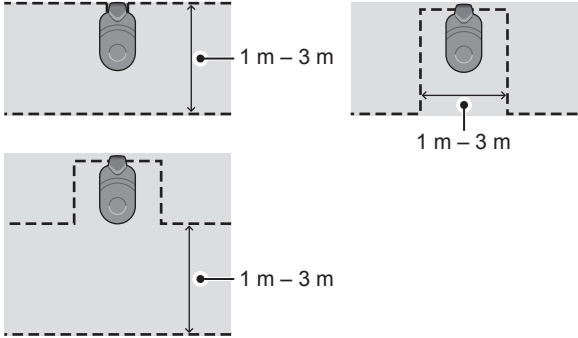
● Installing boundary wire and connecting to the docking station

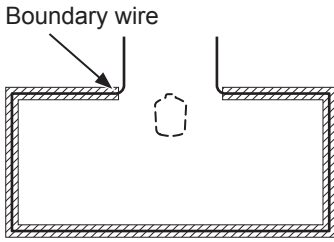
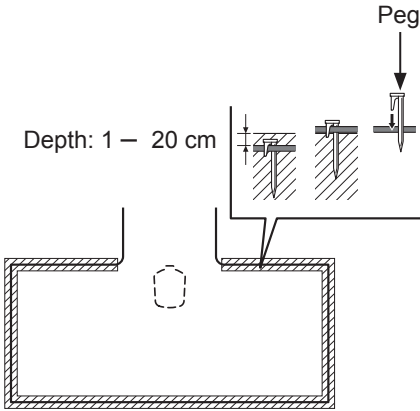
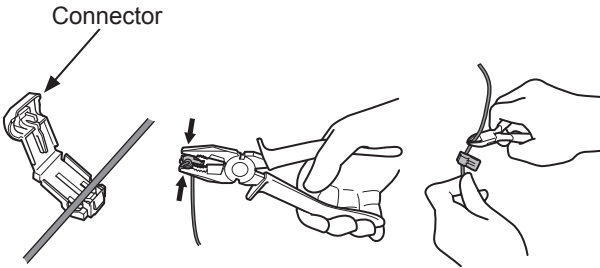
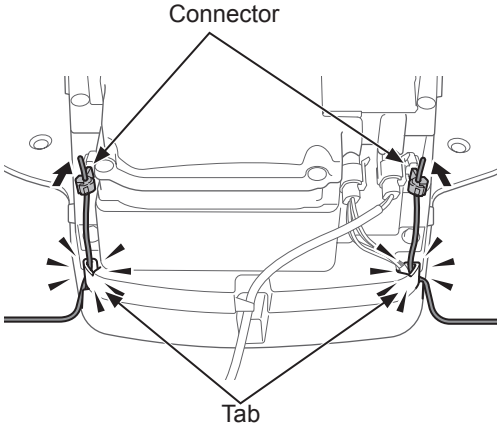
Image	Operation
	<p>Set the boundary wire by using the “LAWN DIAGRAM” (☞ page 97).</p> <ul style="list-style-type: none"> • Leave enough wire to ensure that small adjustments can be made, double backing outside of the loop is acceptable. • Do not fix the wire until finish the layout. • Boundary wire should be laid so that there is no excess wire.
	<p>Fix the boundary wire with pegs to the specified depth as shown.</p>
	<p>Attach a connector to both ends of the boundary wire.</p> <ol style="list-style-type: none"> 1. Put the boundary wire in the grip area of the connector. 2. Press the connector click with a plier. 3. Cut the position of 1-2 cm from the each connector.
	<p>The boundary wire must not be crossed when connecting to the docking station. The right hand wire end must be connected to the right hand pin on the docking station and the left hand wire end to the left pin.</p> <ol style="list-style-type: none"> 1. Remove the station cover (☞ page 66). 2. Pass the boundary wire through the tabs. 3. Insert the connectors into the pins. 4. Install the station cover. <p>NOTE</p> <ul style="list-style-type: none"> - To connect the AC adapter to the docking station, refer to page 66.

Setting up the lawnmower

When turning the lawnmower on initially, the initial settings will appear.

Through the initial settings, you can configure the display language, internal date and time, and create your PIN (Personal Identification Number).

Once initial settings are done, you can configure the settings for the mowing operation of your lawnmower using the setup wizard.

Setup wizard can be done on the display or using Mii-monitor smartphone/tablet application.

NOTE:

- If your dealer already configured the setup wizard, the setup wizard screen is not displayed.

Turning on the power

After the battery is charged, press the **(On)** button to turn on the lawnmower.

The **(On)** button is located on the control panel towards the rear side of the lawnmower.

⚠ WARNING

- Do not insert your finger beneath the closed control panel cover.

- 1 Press the manual STOP button.
The control panel cover pops up.

Manual STOP button

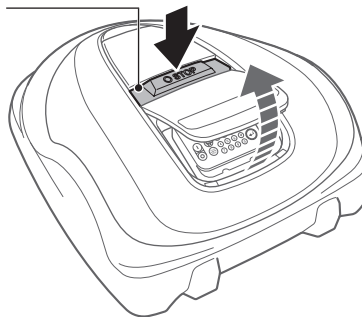

- 2 Press the **(On)** button on the control panel.

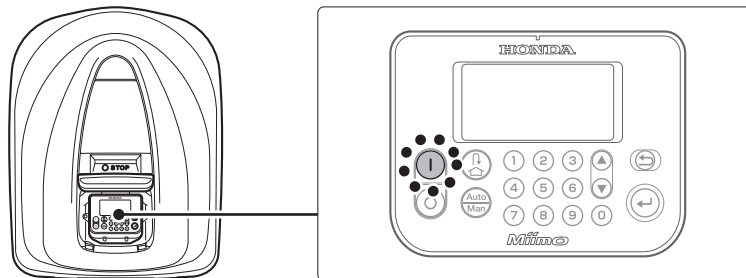

The power turns on, and the initial setup screen on the control panel is displayed.

Initial settings

When turning the lawnmower on initially, the initial settings will appear to set the display language, internal date and time, and create your PIN (Personal Identification Number).

Initial settings are performed on the control panel. After initial settings, you can use Mii-monitor to change the settings.

⚠ WARNING

- Make sure to press the manual STOP button before performing the following procedure.

1

Select your preferred language and press the  button.

Initial setup
Select language
1.English
2.Deutsch
3.Français
4.Italiano
5.Nederlands
6.Svenska

2

Enter the date with the format {Day}/{Month}/{Year} and the time in 24-hour format.

Initial setup
Set date and time
D D/MM/20YY
: (24h)
OK

3

Select [OK] and press the  button.

Initial setup
Create a PIN code
█ _ _ _
OK

4

Input a PIN using the number buttons.

NOTE:

- Write down your PIN in the space provided. See "DEALER CHECKSHEET" (☞ page 100).

5

Select [OK] and press the  button.

The message "Select install menu" is displayed. You can select the setup method.

- [1.Setup wizard] ... Step-by-step setup (☞ page 19)
- [2.Advanced setup] ... Set up the Mowing setting/Quiet timer only (☞ page 30)
- [3.Restart initial setup] ... Redo initial setup

Select install menu
1.Setup wizard
2.Advanced setup
3.Restart initial setup
Finish

Initial setup is completed. Go to the setup wizard to configure the settings for the mowing operation of your lawnmower.

You can execute the setup wizard not only on the control panel of the lawnmower, but also in Mii-monitor. If you have not yet installed Mii-monitor, refer to "5 Mii-monitor Preparation" (☞ page 62).

■ Configuring the settings through the setup wizard

This section explains the setup wizard procedure using the control panel on the lawnmower. The setup wizard will guide you to configure the settings for your mowing operation as follows:

Menu name	Usage	Configuring and testing the settings
[1. Cutting height]	For setting the height of the lawnmower blades.	- Blade height
[2. Garden layout]	For configuring the settings related to the layout of the boundary wire. These setting values are referred from the other settings.	- Direction for the lawnmower to dock to the docking station - Length of the boundary wire - Garden size - Existence of narrow passages
[3. Mowing start points]	For configuring the mowing start point settings to enable the lawnmower to start mowing from other areas than from docking station.	- Direction of the mowing start points - Distance of the start points from the docking station - Ratio with which the lawnmower operates in each area
[4. Test start points]	For testing the start points configured in [3. Mowing start points] menu.	- Testing the setting of each start point
[5. Work timer]	For setting the work timer to operate the lawnmower according to the schedule.	- Work day and work time - Seasonal work time

NOTE:

- Before starting the setup wizard, confirm the completion of installing the docking station and laying boundary wire with your dealer.
- Before starting the setup wizard, fill out the DEALER CHECKSHEET at the end of the Owner's Manual.
- If the DEALER CHECKSHEET at the end of Owner's Manual was already filled out by your dealer, refer to it when configuring the settings through the setup wizard.
- After the settings are finished through the setup wizard, you can modify the setting values in the menu settings. For details, see "4. MENU SETTINGS" (☞ page 32).
- You can also modify the setting values in Mii-monitor.

1. Setting the cutting height

Through this setting, you can set the height of the lawnmower blades.

- 1-1** Select [1.Setup wizard] and press the  button.
Setup wizard top screen is displayed.



- 1-2** Select [1.Cutting height] and press the  button.
Cutting height screen is displayed.



- 1-3** Select [1. Auto setup] or [2. Manual setup] and press the  button.

Menu name	Description
[1.Auto setup]	Lawnmower will gradually reduce the cutting height from the "start height" to the "target height" that you prefer.
[2.Manual setup]	Cutting height will be fixed at your preferred grass length.

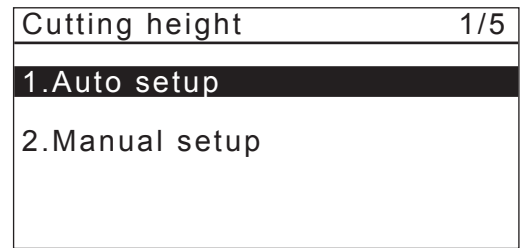

If you select [1. Auto setup], go to step 1-4.
If you select [2.Manual setup], go to step 1-6.

- 1-4** Set the "Target cutting height" with the   buttons or number buttons and press the  button.

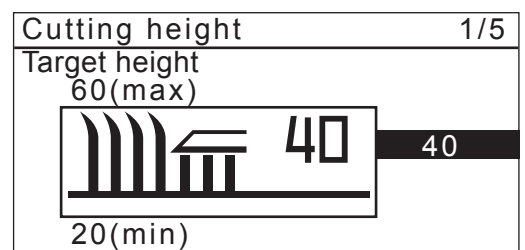

1-5

Set the "Start cutting height" with the ▲▼ buttons or number buttons and press the ⏪ button.

NOTE:

- We recommend that your lawn is cut to a height of less than 65mm before using Miimo.
- If you selected [1.Auto setup], the cutting height will decrease 5 to 20 mm per week. (The speed at which it decreases varies depending on the work load.)
- If lawnmower faces high work load, the cutting height may increase 5 mm.
- If lawnmower is turned off for more than 1 week, the cutting height is reset to 60 mm.
- The lawnmower may not operate correctly under the following conditions.
 - The blades are worn out.
 - Dirt and cut grass have accumulated in the working parts such as the blade disc.
 - The work timer has not been set for a long enough period to mow the entire lawn.
 - There are obstacles such as branches and rocks on the lawn.

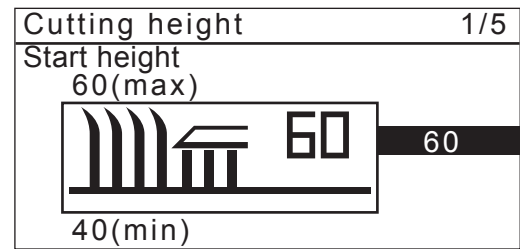

1-6

Press the ▲▼ buttons to select a blade height.

NOTE:

We recommend that you set a height that cuts off 5 mm maximum from the current grass height.

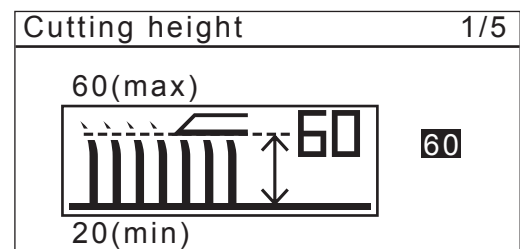

1-7

Press the ⏪ button.

The configuration of cutting height is completed. The setup wizard top screen is displayed and [1.Cutting height] is checked.

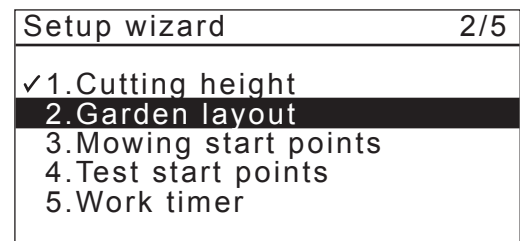

2. Setting the garden layout

Through this setting, you can configure the information of your garden layout for operating the lawnmower.

2-1

[2.Garden layout] is selected. Press the **⏪** button to configure the garden layout.
Garden layout screen is displayed.

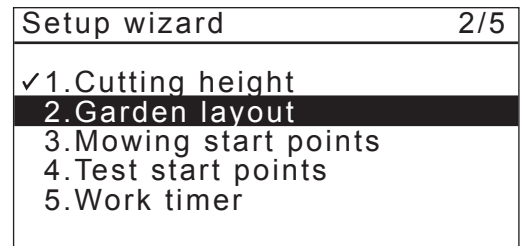

2-2

Select an installation pattern for the docking station, and press the **⏪** button.
Refer to page 12, to confirm which pattern matches your actual installation.

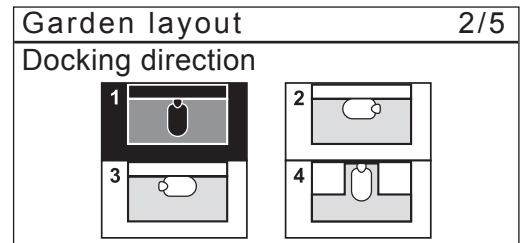

2-3

Enter the values of the boundary wire length and garden size.

NOTE:

- For details on the boundary wire length or garden size, contact your dealer.
- Input the boundary wire length exactly because the values which are automatically configured are associated with the boundary wire length.

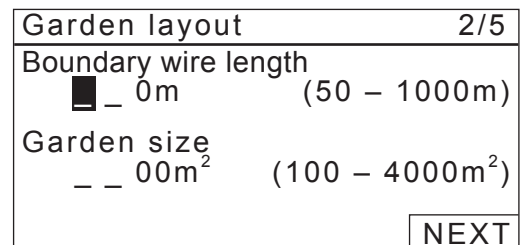

2-4

Select [NEXT] and press the **⏪** button.

2-5

Select [Yes] or [No] to the question on the narrow passages, and press the **⏪** button..
Narrow passages have a passage width of 3.0 m or less.
[YES] → Go to Step 2-6
[NO] → Go to "3.Setting the mowing start points"
(☞ page 23)

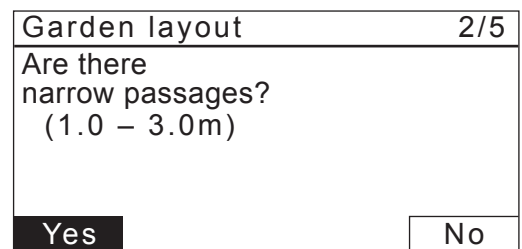

2-6

Check that the value is selected and press the **⏪** button, use the number buttons to input a value from 1.0 to 3.0 m.

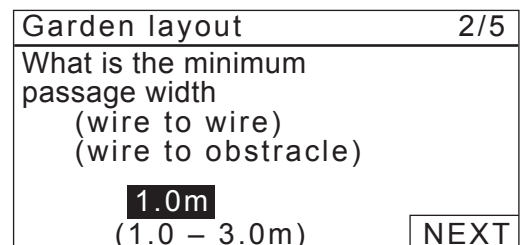

2-7

When you are finished inputting a value, press the **⏪** button. [NEXT] will be selected. Press the **⏪** button again.
The configuration of garden layout is completed.
The setup wizard top screen is displayed and [2.Garden layout] is checked.

3. Setting the mowing start points

Through this setting, you can set the starting point to operate the lawnmower.

If you set the mowing start points and combine them with the settings of work timer, you can effectively mow your garden.

3-1

Select [3.Mowing start points] and press the  button to configure the mowing start points.

Mowing start points screen is displayed.

Setup wizard	3/5
✓1.Cutting height	
✓2.Garden layout	
3.Mowing start points	
4.Test start points	
5.Work timer	

3-2

Select [Yes] or [No] to the question on the addition of the start points and press the  button.

If you select [Yes], go to step 3-3.



If you select [No], no start point is added and the setup wizard top screen is displayed.

NOTE:

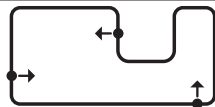
- When selecting [No], [3.Mowing start points] and [4.Test start points] are checked on the setup wizard top screen.
- When selecting [No], the lawnmower will always start mowing from the docking station.

Mowing start points	3/5
	
Are additional start points needed?	
Yes	No



3-3

Select  (Clockwise) or  (Anticlockwise), enter the values of the distance from the docking station to start cutting, and enter a percentage of the ratio which the lawnmower operates.

Repeat the above operation for the starting points which you want to configure.

NOTE:

- You can configure 5 start points.
- Input the usage percentage for each start point based on how often the lawnmower should start from this point once charged.
- Start point does not define a specific area of mowing. It ensures the lawnmower can reach areas difficult to access in your garden.

Mowing start points	3/5
Point  /  (0 - 50m)	
1 <input type="checkbox"/> / <input type="checkbox"/> - - - m - - 0%	
2 <input type="checkbox"/> / <input type="checkbox"/> - - - m - - 0%	
3 <input type="checkbox"/> / <input type="checkbox"/> - - - m - - 0%	
4 <input type="checkbox"/> / <input type="checkbox"/> - - - m - - 0%	
5 <input type="checkbox"/> / <input type="checkbox"/> - - - m - - 0%	
	NEXT

3-4

Select [NEXT] and press the  button.

The configuration of mowing start points is completed.

The setup wizard top screen is displayed and [3.Mowing start points] is checked.

NOTE:

- You can modify again the settings through the setup wizard.

4. Testing the Start points

Through this testing, you can check the start points which you added in [3.Mowing start points].



NOTE:

- Perform each test when the lawnmower is connected to the docking station.

4-1 Select [4.Test start points] and press the  button to check the start points.

Setup wizard	4/5
✓1.Cutting height	
✓2.Garden layout	
✓3.Mowing start points	
4.Test start points	
5.Work timer	

4-2 Select a start point number and press the  button. The information of the selected start point is displayed.

Test start points	4/5
Point  / 	
1 <input checked="" type="checkbox"/> / <input type="checkbox"/>	50m
2 <input type="checkbox"/> / <input type="checkbox"/>	m
3 <input type="checkbox"/> / <input type="checkbox"/>	m
4 <input type="checkbox"/> / <input type="checkbox"/>	m
5 <input type="checkbox"/> / <input type="checkbox"/>	m
0 Home	NEXT

4-3 Confirm the setting information of the selected start points.

Test start points	4/5
Point1	
Location	CW 50m
Passage width	2
Dock the mower in the station	

4-4 Close the control panel cover. The lawnmower starts towards the selected start point. When the test is correctly finished, the lawnmower rolls slowly from the minimum to the maximum exit angle, and a beep sound is emitted from the lawnmower.

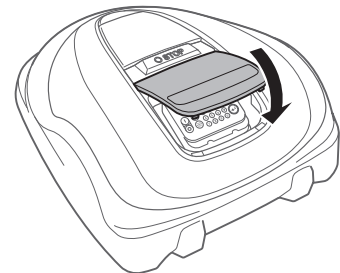

4-5 Press the manual STOP button. The control panel cover pops up. The message “Do you want to modify the start point?” appears on the display.

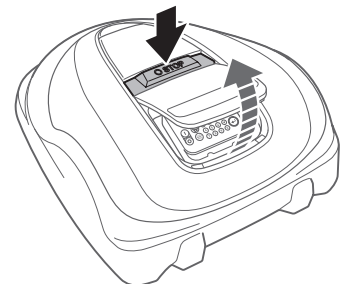

4-6 Select [Yes] or [No] to the question of the test result and press  button. If you select [Yes], the Mowing start points screen is displayed to configure the start point settings. If you select [No], go to step 4-7.

Test start points	4/5
Do you want to modify the start point?	
Yes	No

NOTE:

- For details on the start point settings, see step 3-3 of “3. Setting the mowing start points” (page 23).

4-7 Test the return home of the lawnmower to the docking station.
Select [0 Home].

Test start points		4/5
Point		
1	<input checked="" type="checkbox"/> / <input type="checkbox"/>	50m
2	<input type="checkbox"/> / <input type="checkbox"/>	m
3	<input type="checkbox"/> / <input type="checkbox"/>	m
4	<input type="checkbox"/> / <input type="checkbox"/>	m
5	<input type="checkbox"/> / <input type="checkbox"/>	m
0	Home	NEXT

4-8 Select [Clockwise (CW)] or [Anticlockwise (ACW)] and press  button.

Test return home		4/5
Select direction to home		
Clockwise (CW)		
Anticlockwise (ACW)		

4-9 Confirm the selecting information of the selected direction to home.

Test return home		4/5
Home		
Location	CW	
Close cover to start		

4-10 Close the control panel cover.
The lawnmower starts towards the the docking station.

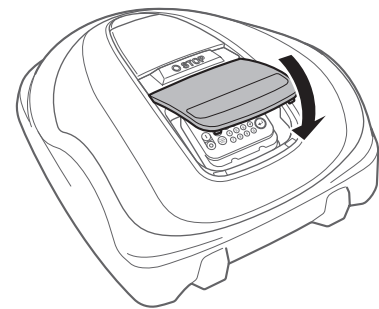

4-11 Press the manual STOP button.
The control panel cover pops up.
The message "Test finished" appears on the display.

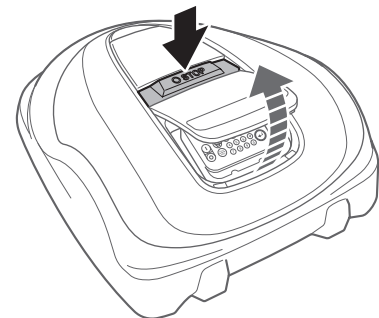

4-12 Select [NEXT] and press the  button.
The configuration of testing start points is completed.
The setup wizard top screen is displayed and [4. Test start points] is checked.

Test start points		4/5
Home		
Test finished		
		NEXT

5. Setting the work timer

With this setting, you can configure the work day and work time at which the lawnmower operates in auto mode.

5-1

Select [5.Work timer] and press the  button to configure the work day and work time.

Setup wizard	5/5
✓1.Cutting height ✓2.Garden layout ✓3.Mowing start points ✓4.Test start points 5.Work timer	

5-2

Select [1. Auto fill up timer] or [2. Manual setup] and press the  button.

Menu name	Description
[1.Auto fill up timer]	For automatically calculating the minimum required dates of the week referring to the boundary wire length and garden size.
[2.Manual setup]	For manually setting the work day and work time to operate the lawnmower. You can configure the proper settings with your garden.

Work timer	5/5
Recommended	10hrs/week
1.Auto fill up timer	
2.Manual setup	

If you select [1.Auto fill up timer], go to step 5-3.
 If you select [2.Manual setup], go to step 5-5.

NOTE:

- If you do not know the details on the work timer settings, select [1.Auto fill up timer], or contact your dealer.
- For details on the work timer settings, see “4. MENU SETTINGS” (page 32).
- According to the mowing results with the settings which are automatically configured by the system, it may be necessary to adjust the values for operating the lawnmower. If you do not know the details on the settings, contact your dealer.

5-3

Select the preferred time for when the lawnmower should automatically operate. After selecting, select [NEXT] and press the  button.

[Day]: Operates mostly in the morning or afternoon.
 [Night]: Operates mostly at night.

Work timer	5/5
Preferred mowing time	
<input checked="" type="checkbox"/> Day <input type="checkbox"/> Night	
NEXT	

5-4

Confirm the days which are automatically selected referring to the boundary wire length and garden size. Select [NEXT] and press the \ominus button to proceed to the timer setting screen.

NOTE:

- You can select other days to operate the lawnmower.

5-5

If you select [1.Auto fill up timer] in step 5-2, confirm the days which are automatically configured referring to the boundary wire length and garden size.

If you want to change the work time, select the day and press the \ominus button to change the work time of the lawnmower.

If you do not want to change the work time, select [OK] and press the \ominus button. Go to step 5-7.

If you select [2.Manual setup] in step 5-2, select the day and press the \ominus button to change the work time of the lawnmower.

Work timer	5/5
Minimum days required 7	
<input type="checkbox"/> All	<input checked="" type="checkbox"/> MON <input checked="" type="checkbox"/> TUE
<input checked="" type="checkbox"/> WED	<input checked="" type="checkbox"/> THU <input checked="" type="checkbox"/> FRI
<input checked="" type="checkbox"/> SAT	<input checked="" type="checkbox"/> SUN NEXT

OK	0	6	12	18	24
MON			■	■	
TUE			■	■	
WED			■	■	
THU			■	■	
FRI			■	■	
SAT			■	■	
SUN			■	■	

5-6

Enter a start time and an end time in 24-hour format for [1]. If you want to split the day into two work times, also enter a start time and an end time in 24-hour format for [2].

NOTE:

- If selecting [Copy to week] and pressing the \ominus button, you can copy the settings to the other days. For details on this operation, see "4 MENU SETTINGS" (⌘ page 32).

Work timer	5/5
Monday	
1	From 9:00 - to 12:00
2	From 14:00 - to 18:00
Copy to week	

5-7

Press the $\omin�$ button to return to the previous screen.

5-8

Select [OK] and press the $\omin�$ button.

5-9

If desired, select start points to be used each day by pressing the $\omin�$ button to select the day.

NOTE:

- The check boxes which you configured in [3.Mowing start points] are displayed.
- When you are finished, select [NEXT] and press the $\omin�$ button. You are returned to the screen in step 5-9.

OK	Timer1	Timer2
MON	1 2	
TUE	1 2	1 2
WED	1 2	
THU	1 2	1 2
FRI	1 2	
SAT	1 2	1 2
SUN	1 2	1 2

Set start points	
Monday	
1	1 2 3 4 5
	<input checked="" type="checkbox"/> <input checked="" type="checkbox"/>
2	1 2 3 4 5
NEXT	

5-10

Select [OK] and press the $\omin�$ button.

5-11

Confirm the achieved and recommended hours per week. Select [NEXT] or [No] and press the  button.

If you select [NEXT], go to step 5-12.

If you select [No], go to step 5-5.

Work timer	5/5
Achieved	10hrs/week
Recommended	10hrs/week
No	NEXT

5-12

Select [1. Auto setup] or [2. Regional setup] or [3. Deactivate] and press the  button.

NOTE:

- The growth speed of a lawn depends on the season and weather conditions. With this function you can set the ratio of the work timer as season and weather conditions change.

Work timer	5/5
Seasonal timer	
1.Auto setup	
2.Regional setup	
3.Deactivate	

Menu name	Description
[1. Auto setup]	Automatically reduces the work timer when lawn growth is slow (cutting work load is low), and reverts the work timer when lawn growth is fast (cutting work load is high).
[2. Regional setup]	Select your region and set the mowing time ratio for each month.
[3. Deactivate]	Do not set a seasonal timer. lawnmower will mow at 100% of the work timer that you have set.

If you select [2.Regional setup], go to step 5-13.



If you select [1. Auto setup] or [3. Deactivate], go to step 5-15.

NOTE:

- If you selected [1. Auto setup], Auto mode cannot reduce the work timer to be less than 40% of the maximum.
- If you selected [1. Auto setup], the work timer will not increase over what you set even when lawn growth is fast. The work timer is the maximum that lawnmower will mow. If you want lawnmower to mow for longer, you should increase the work timer.
- The lawnmower may not operate correctly under the following conditions even when seasonal timer is set.
 - The blades are worn out.
 - Dirt and cut grass have accumulated in the working parts such as the blade disc.
 - The work timer has not been set for a long enough period to mow the entire lawn.
 - There are obstacles such as branches and rocks on the lawn.

5-13

Select your region and press the  button.

Seasonal timer	
Select your region.	
1.North	
2.North Central	
3.South Central	
4.South	

5-14

Confirm each month's ratio, select [NEXT].

NOTE:

- You can modify the values for operating the lawnmower.
- According to the mowing results with the settings which are automatically configured by the system, it may be necessary to adjust the values for operating the lawnmower. If you do not know the details on the settings, contact your dealer.

Seasonal timer							
JAN	0	0	0 %	JUL	1	0	0 %
FEB	0	0	0 %	AUG	1	0	0 %
MAR	0	4	0 %	SEP	0	8	0 %
APR	0	6	0 %	OCT	0	4	0 %
MAY	0	8	0 %	NOV	0	0	0 %
JUN	1	0	0 %	DEC	0	0	0 %
							NEXT

5-15

Press the  button.

Setup wizard top screen is displayed and [5.Work timer] is checked.

Setup wizard	5/5
<ul style="list-style-type: none"> ✓1.Cutting height ✓2.Garden layout ✓3.Mowing start points ✓4.Test start points ✓5.Work timer 	Finish

5-16

Select [Finish] and press the  button.

Initial setup complete screen is displayed.

NOTE:

- If you want to modify the settings in this menu, select this menu again. You can configure the settings through the setup wizard.

Setup wizard	5/5
<ul style="list-style-type: none"> ✓1.Cutting height ✓2.Garden layout ✓3.Mowing start points ✓4.Test start points ✓5.Work timer 	Finish

5-17

Select [Finish] and press the  button.

Initial setup is completed and Home screen is displayed.

Select install menu
<ul style="list-style-type: none"> 1.Setup wizard 2.Advanced setup 3.Restart initial setup
Finish

■ Configuring the settings through the advanced setup

The advanced setup will guide you to configure the settings for your mowing operation as follows:

Menu name	Settings
[1. Mowing setting]	<ul style="list-style-type: none"> - Mowing pattern - Wire overlap - Edge cutting - Spiral cutting
[2. Quiet timer]	<ul style="list-style-type: none"> - Blade speed - Wheel speed - Timer

1. Mowing setting

1-1

Select [1. Mowing settings] or [2. Quiet timer].
 If you select [Mowing settings], go to step 1-2.
 If you select [Quiet timer], go to step 2-1.

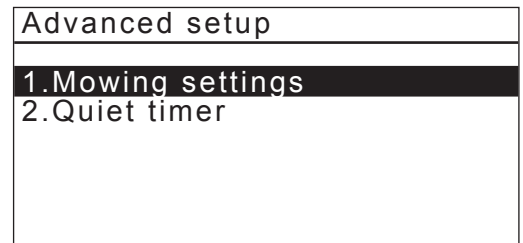

1-2

Select a start point and press the  button.
 If you select [NEXT], go to step 1-4.

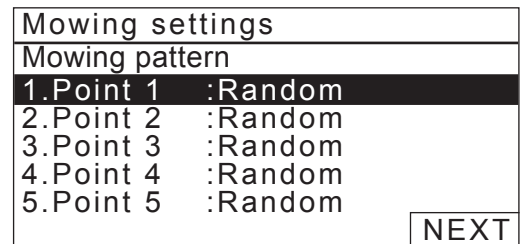

1-3

You can select [Random], [Directional], or [Mixed] for the mowing pattern.

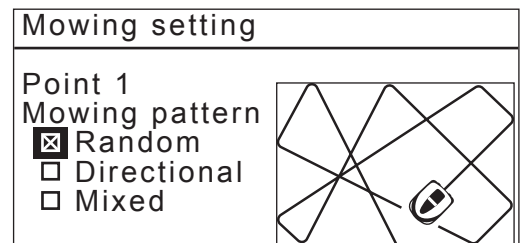

1-4

Enter the value from 20 to 45 (cm).
 Select [NEXT] and press the  button.

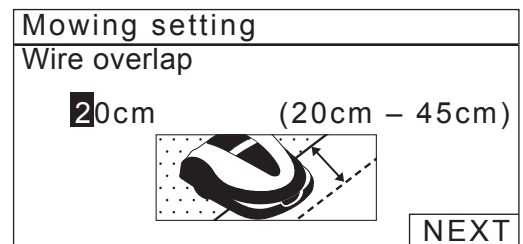

1-5

Select [ON] or [OFF] and press the  button.

If you select [ON], go to step 1-6.
If you select [OFF], go to step 1-8.

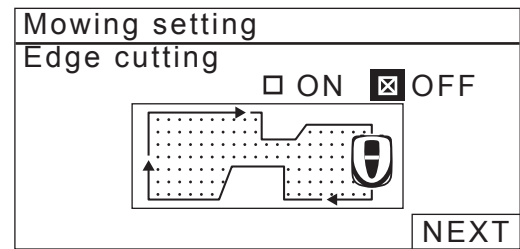

1-6

Select [CW], [ACW], or [Mixed] for the edge cutting direction.

Select [NEXT] and press the  button.

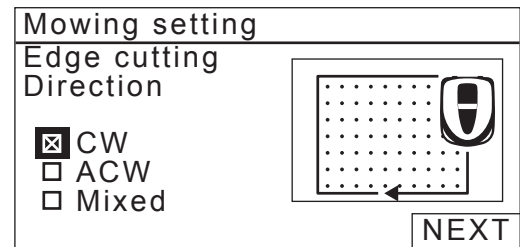

1-7

Select the day of the week on which you want the lawnmower to run with the edge cutting function, and press the  button.

Select [NEXT] and press the  button.

You can select up to two workdays per week.

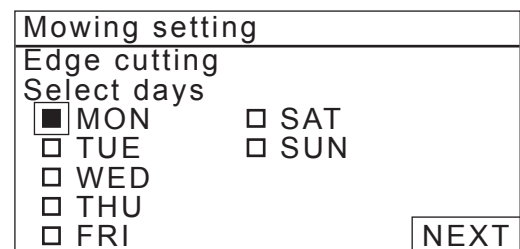

1-8

Select [ON] or [OFF] and press the  button.

If you select [Finish] and press the  button, you will be returned to the screen in step 1-1.

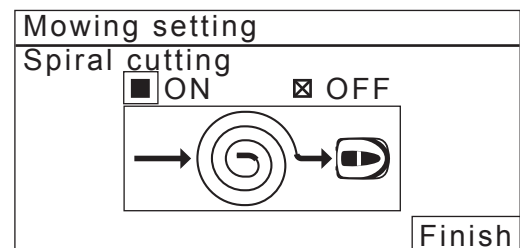



2. Quiet timer

2-1

[Blade speed]: Select [Low] or [Normal] and press the  button.

2-2

[Wheel speed]: Configure the wheel speed level with which you want the lawnmower to operate by pressing the   buttons. Press the  button.

2-3

[Timer]: Enter a start time and end time in 24-hour format using the number buttons. Press the  button.

2-4

Press the  button to return to the previous screen.

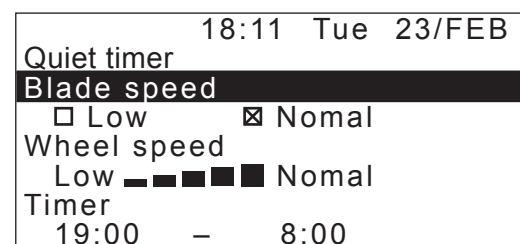

4 MENU SETTINGS

The control panel menus are used to set how the lawnmower operates. The menu settings can also be accessed in Mii-monitor. You can use Mii-monitor to save the settings. You can also restore saved settings.

Menu overview

NOTE:

- We recommend having your dealer change these settings during installation.

● Menu screen

Selecting [Menu] in the home screen and press the  button, Menu screen is displayed as below:

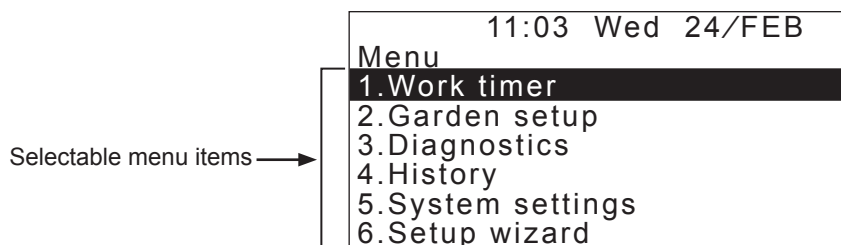

The menu consists of multiple levels of submenus. The uppermost levels are as follows:

Menu name	Usage	See this page for information
[1.Work timer]	For setting the work day and work time, and selecting the start points.	(☞ page 34)
[2.Garden setup]	For configuring the lawnmower to operate.	(☞ page 38)
[3.Diagnostics]	For diagnosing the lawnmower.	(☞ page 52)
[4.History]	For viewing operation and error history.	(☞ page 55)
[5.System settings]	For configuring system-related settings.	(☞ page 58)
[6.Setup wizard]	For configuring the setting through the set up wizard according to the steps of the screens.	(☞ page 19)

Full menu diagram

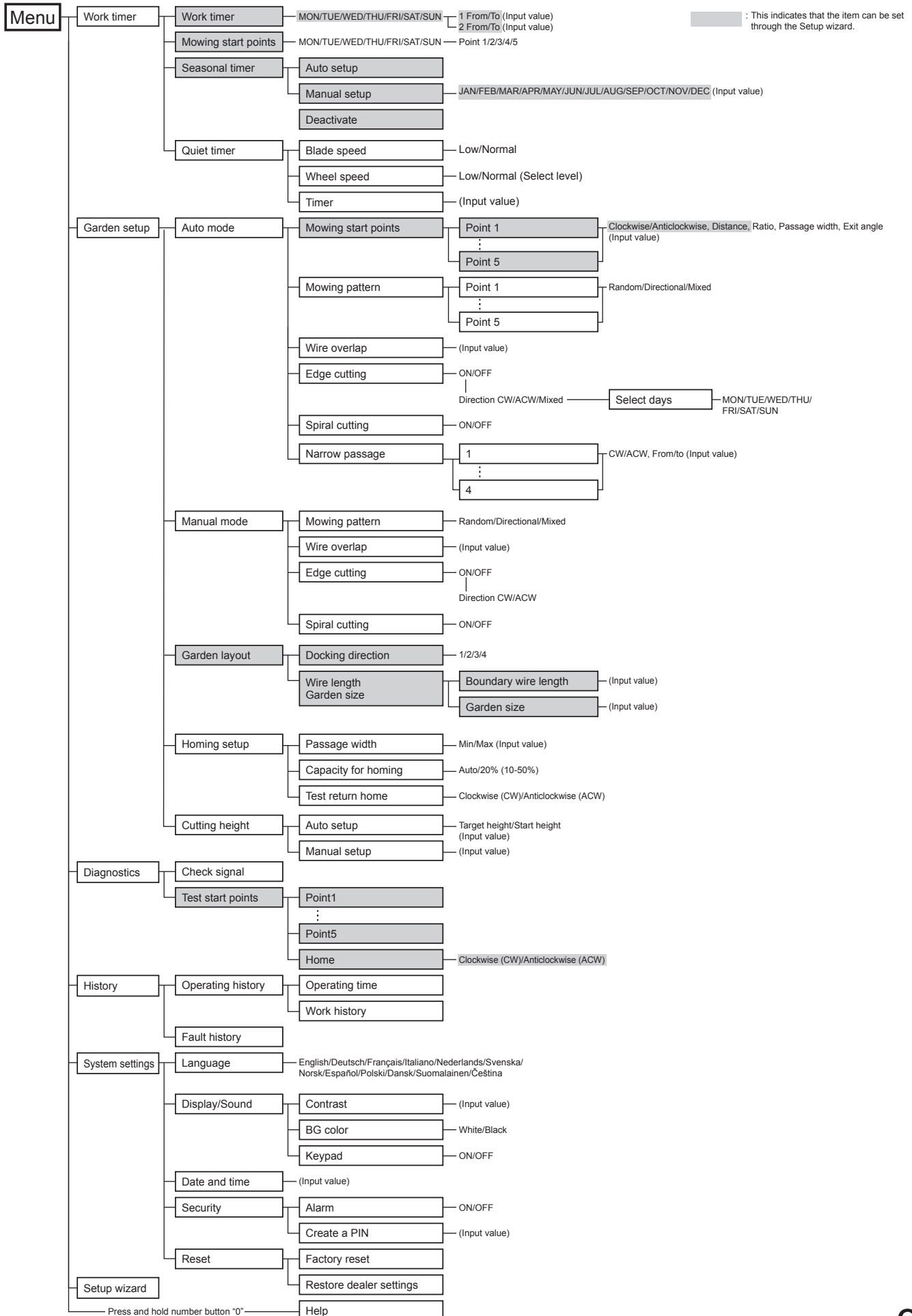

Setting the work timer

You can set the work day and work time for the lawnmower to operate. You can also specify a specific area for each work time.

Work timer

You can select the day and time on which you want the lawnmower to operate.



Home screen → Menu screen → [1. Work timer] → [1. Work timer]

Configure this setting to have the lawnmower operate on specific days and times.

You can set up to two times for operation for one day.

NOTE:

- The [Timer 1] cannot be overlapped with the [Timer 2].
- The period of time cannot include "00:00".

- 1 Select the day on which you want the lawnmower to operate.
 - 2 Press the ⏪ button to proceed to the timer setting screen.
 - 3 Enter a start time and an end time in 24-hour format for [Timer 1] using the number buttons.
 - 4 If necessary, also enter a start time and an end time in 24-hour format for [Timer 2].
- NOTE:**
- If you want to copy the work timer settings to the other days of week, select [Copy to week] and the ⏪ button.
- 5 Press the ⏩ button to return to the previous screen.

The percentage which is configured in the seasonal timer is the ratio in which the lawnmower works in a month. For details on the seasonal timer, see "Seasonal timer" (page 36).

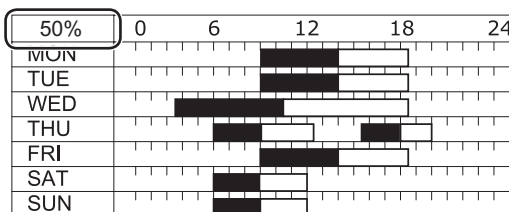

Confirm the period of work time for each day of week.

NOTE:

- Black part in the bar is the time in which the lawnmower will work. White part in the bar is the time in which lawnmower will not work. The ratio of black and white parts depends on the settings of seasonal timer. For details on the seasonal timer, see "Seasonal timer" (page 36).

Set the time. →

Work timer

Monday

1 From 9:00 to 12:00

2 From 14:00 to 15:00

Copy to week

Work timer

Select days to copy

All MON TUE

WED THU FRI

SAT SUN

Yes No

If you want to copy the work timer settings to the other days of week, select [Copy to week] and the ⏪ button.

Select each box of the day to which you want to copy and press the ⏪ button. After adding checks to the boxes, select [Yes] and press the ⏪ button to copy the settings to the selected days of week.

Mowing start points

You can set the mowing start points for each day of week. For example, if you set the following 5 start points in your garden, you enable the lawnmower to reach other areas through narrow passages for a better efficiency.

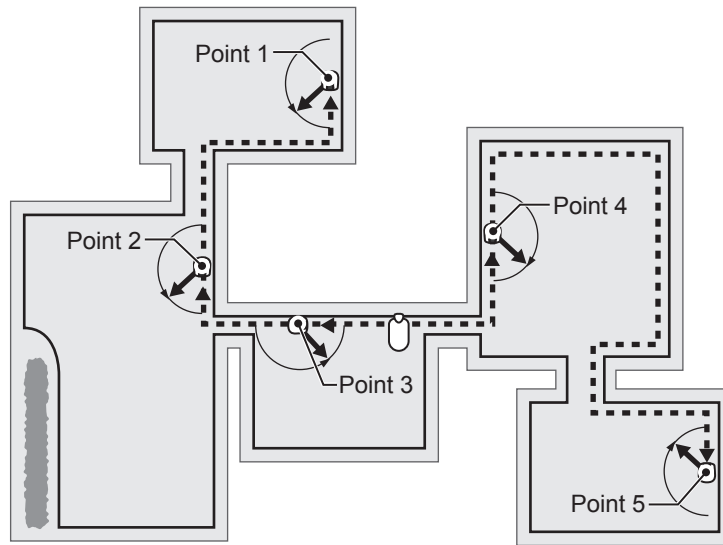

By setting the start points for each day of week, you can effectively operate the lawnmower to mow your garden such as below:

	Timer1	Timer2
MON	1 2 3	
TUE	1 2 3	
WED	1 2 3	
THU		3 4 5
FRI		3 4 5
SAI		
SUN		

From Monday to Wednesday: the lawnmower starts mowing from point 1, point 2, or point 3.

From Thursday to Friday: the lawnmower starts mowing from point 3, point 4, or point 5.

Start points					
Monday					
1	<input checked="" type="checkbox"/>	<input checked="" type="checkbox"/>	<input checked="" type="checkbox"/>	<input type="checkbox"/>	<input type="checkbox"/>
2	<input type="checkbox"/>	<input type="checkbox"/>	<input type="checkbox"/>	<input type="checkbox"/>	<input type="checkbox"/>
NEXT					

Checkboxes are displayed only for configured start points. (In the screen on the left, 5 start points are configured.)

Menu screen
 Home screen → [1.Work timer] → [2.Mowing start points]

Configure this setting to make the lawnmower start mowing from specific start points on specific days of week.

- 1 Select the day and press the ⏪ button.
- 2 Add a check to the box by pressing the ⏪ button to select the start points.
- 3 If you want to set the start points in detail, see the setup wizard top screen is displayed and [3.Mowing start points] is checked.
- 4 Press the ⏩ button to return to the previous screen.

Seasonal timer

The growth speed of lawn depends on the season. With this function, you can configure the ratio of the mowing time for each season.

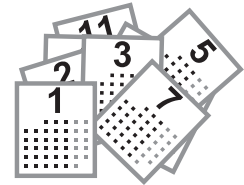

 **Home screen** → Menu screen → **[1.Work timer]** → **[3.Seasonal timer]** → **[1.Auto setup]**

Automatically reduces the work timer when lawn growth is slow (cutting work load is low), and reverts the work timer when lawn growth is fast (cutting work load is high).

NOTE:

- Auto mode cannot reduce the work timer to be less than 40% of the maximum.
- The work timer will not increase over what you set even when lawn growth is fast. The work timer is the maximum that lawnmower will mow. If you want lawnmower to mow for longer, you should increase the work timer.

1 Press the ⏪ button to return to the previous screen.

17:01 Fri 17/APR
Seasonal timer
1.Auto setup <input checked="" type="checkbox"/>
2.Manual setup <input type="checkbox"/>
3.Deactivate <input type="checkbox"/>

 **Home screen** → Menu screen → **[1.Work timer]** → **[3.Seasonal timer]** → **[2.Manual setup]**

Configure this setting to have a percentage of each month of lawnmower operation.

1 Enter a percentage of each month using the number buttons.

2 Select [OK] and press the ⏪ button to return to the previous screen.

Seasonal timer			
JAN	020%	JUL	100%
FEB	050%	AUG	100%
MAR	100%	SEP	090%
APR	100%	OCT	080%
MAY	100%	NOV	060%
JUN	100%	DEC	040%
			OK

Set the ratio of the mowing time for each month.
Example: If the work time in February is set to 50% and the work timer for one day is 10 hours, the mowing time for one day will be 5 hours.

 **Home screen** → Menu screen → **[1.Work timer]** → **[3.Seasonal timer]** → **[3.Deactivate]**

You can deactivate the timer for each season for operating the lawnmower. If the seasonal timer is deactivated, the lawnmower works 100% for each month.

1 Press the ⏪ button to return to the previous screen.

■ Quiet timer

You can set the blade speed, wheel speed and timer for operating the lawnmower quietly.



 **Home screen** → Menu screen → **[1.Work timer]** → **[4.Quiet timer]** (“ON” is checked)

Configure this setting to operate the lawnmower with low noise during the period which you configure.

1



Select [Blade speed] and press the  button.

If you want the lawnmower to mow on your lawn quietly, select [Low].

2

Press the  button.

3

Select [Wheel speed] and configure the wheel speed level with which you want the lawnmower to operate by pressing the   buttons.

4

Press the  button.

5

Select [Timer] and enter a start time and an end time in 24-hour format using the number buttons.

6

Press the  button.

7

Press the  button to return to the previous screen.

Configure the blade speed of the lawnmower.

Set a start time and an end time for configuring the time for the quiet operation.

18:11 Tue 23/FEB

Quiet timer

Blade speed

Low Normal

Wheel speed

Low ■■■■■ Normal

Timer

19:00 - 8:00

Configure the wheel speed of the lawnmower.

TIPS Decreasing the wheel speed may reduce the mowing distance in the set period and leave more grass uncut. In that case, extend the end time of the timer.

Setting the lawnmower operation

Auto mode

You can set up the advanced auto mode settings as follows:

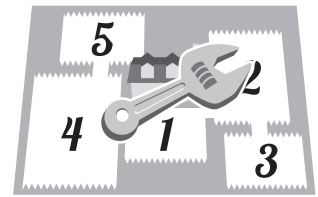

Setting the angle to turn from the boundary wire

When leaving the boundary wire, set the angle to turn from the boundary wire.

🔍 *Angle settings in [1.Mowing start points] (☞ page 40)*

- Set the angle of departure for when the lawnmower arrives at the position specified by the angle of [1.Mowing start point].

Setting the distance to the start point

Until the lawnmower reaches a set starting point in an area, it will run without mowing.

🔍 *Distance settings in [1.Mowing start points] (☞ page 40)*

- Sets the distance from the docking station to start cutting.

Setting the overlap distance on the boundary wire

Set the distance that the lawnmower can cross the boundary wire.

🔍 *[3.Wire Overlap] (☞ page 41)*

NOTE:

- To have the lawnmower smoothly turn from the boundary wire, the recommended value of the Wire overlap is 20 cm.

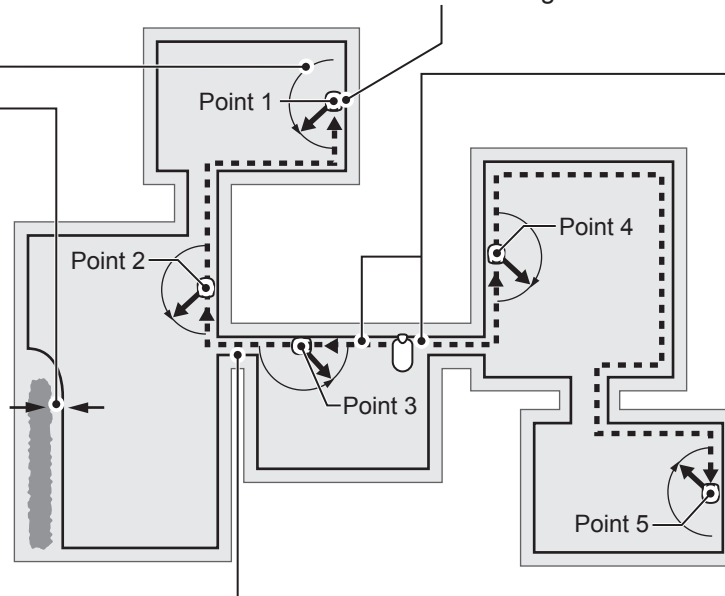

Setting the starting direction from the docking station

Set whether the lawnmower should travel clockwise or anticlockwise along the boundary wire to reach a set starting point.

🔍 *(Clockwise) or (Anticlockwise) in [1.Mowing start point] (☞ page 40)*

Setting the value to reach other areas through the narrow passage

The lawnmower can reach other areas through narrow passages with the following settings:

- Configure the minimum value ("0") of Narrow passage in the Advanced setting. The lawnmower closely follows the boundary wire. This is effective for 5 or more narrow pathways in the garden.
- Configure the value of the narrow passage distance from the docking station. When passing the configured narrow passage, the lawnmower closely follows the boundary wire. This is effective for 4 or fewer narrow pathways in the garden.

🔍 *Width settings in [1.Mowing start points] (☞ page 40)*

🔍 *[6.Narrow passage] (☞ page 44)*

NOTE:

- [6.Narrow passage] setting is for going toward the starting point. If you want to configure the setting for returning to the docking station, you need to set it in the Homing setup. For details, see "Homing setup" (☞ page 48).

NOTE:

- If you want to operate the lawnmower with [Auto mode], see "Operating the lawnmower in Auto mode." (☞ page 69).

Setting the operation ratio of each area operation

Set an area operation ratio if you want to mow more frequently from a certain start point. For example, if you set the ratio for "Point 1" to 30%, the lawnmower will start mowing 3 times out of 10 from "Point 1" and 7 times out of 10 from other start points.

🔍 *Percentage settings in [1.Mowing start points] (☞ page 40)*

NOTE:

- You can configure 5 start points.

Distance from the boundary wire when the lawnmower goes toward the mowing start points:

The lawnmower moves between the boundary wire and the specified value at random as it goes toward the mowing start point.

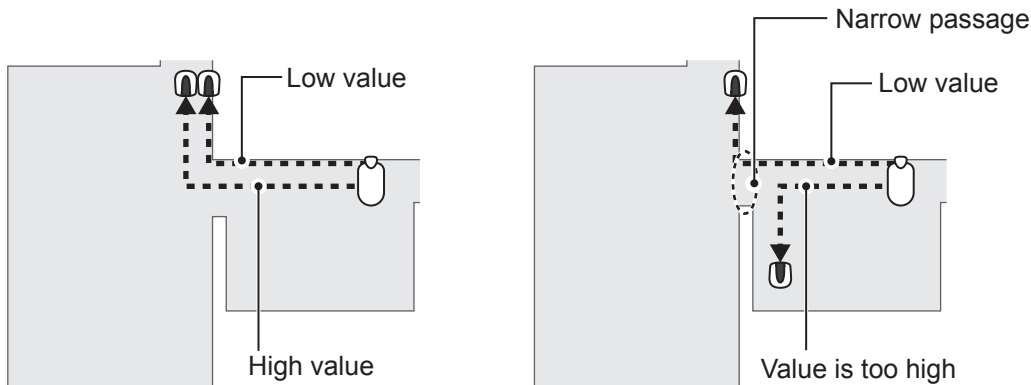

NOTE:

- When the value is too high, lawnmower may not pass through narrow passage.

Passage width sample table

Setup level	Passage width
0	10 cm
1	25 cm
2	30 cm
3	35 cm
4	40 cm
5	50 cm
6	60 cm
7	70 cm
8	80 cm
9	90 cm
10	100 cm
11	110 cm
12	120 cm
13	130 cm
14	140 cm
15	150 cm

Passage width: From boundary wire to middle of the lawnmower

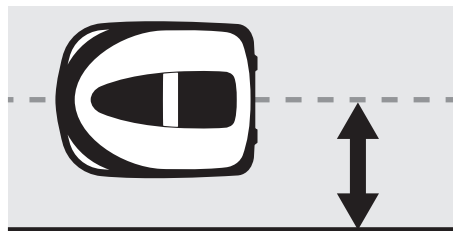

NOTE:

- The field strength varies depending on the length of the boundary wire. The field becomes weaker with a longer boundary wire, and stronger with a shorter boundary wire.
- When the value is high (by avoiding moving along the same path), you can avoid creating wheel tracks in the grass.
- The numerical values of this table are for reference to return the lawnmower to the docking station along a straight line.
- The numerical values may differ depending on the actual conditions.

The angle at which the lawnmower deviates from the boundary wire:

The lawnmower travels to this location along the boundary wire, and then turns away from the boundary wire to start mowing.

You can configure the angle (range) at which the lawnmower deviates from the boundary wire when it starts mowing as below (Default value is from 10° to 170°):

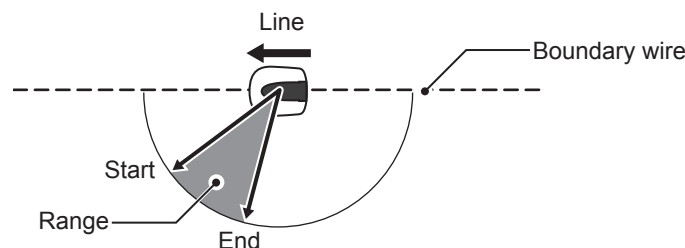

TIPS Use the exit angle to let the lawnmower reach the mowing areas directly instead of using long wire exit locations.

● Mowing start points

 Home screen → ^{Menu screen} [2.Garden setup] → [1.Auto mode] → [1.Mowing start points] → [1.Point 1] to [5.Point 5]

The lawnmower travels to this location along the boundary wire, and then turns away from the boundary wire to begin mowing. This allows you to send the lawnmower to an area which is difficult to access.

TIPS Do not make the distance value bigger than it needs to be. This will maximise the cutting time.

- 1 Select ⌚ (Clockwise) or ⌚ (Anticlockwise), enter the values of the distance from the docking station to start cutting, and enter a percentage of the ratio which the lawnmower operates.
- 2 Select [NEXT] and press the ⏪ button.
- 3 Enter the values of the width setting and angle, and press the ⏪ button.
- 4 Press the ⏪ button to return to the previous screen.

NOTE:

- By selecting [TEST], you can check the settings of each start point before mowing. For details, see "Test start points" (📖 page 53).

Set whether the lawnmower should travel clockwise or anticlockwise along the boundary wire to reach a start point.

Mowing start points			
Point	⌚ / ⌚	(0 - 50m)	
1	⌚ / □	0 m	40 %
2	⌚ / □	0 m	20 %
3	□ / ⌚	0 m	10 %
4	⌚ / □	0 m	10 %
5	□ / ⌚	0 m	20 %
NEXT			

Sets the distance from the docking station to start cutting.

Set an area operation ratio if you want to mow more frequently from a certain start point. Set so that the total of all the percentages is 100%.

Sets the minimum and maximum distance between the lawnmower and the boundary wire when following the boundary wire.

Mowing start points		
Point	Width	Angle
1	3 - 10	10 - 170
2	3 - 10	10 - 170
3	3 - 10	10 - 170
4	3 - 10	10 - 170
5	3 - 10	10 - 170
TEST	(0 - 15)	(10' - 170')

When leaving the boundary wire, set the minimum and maximum angle to turn from the boundary wire.

Menu screen
 Home screen → [2.Garden setup] → [1.Auto mode] →
 [2.Mowing pattern] → [1.Point 1] to [5.Point 5]

You can select from 3 mowing patterns below:

[Random]

With the **[Random]** setting, when the lawnmower detects the boundary wire, it turns at a wide angle. This is the most effective for mowing a large open area of grass. For normal operation, use this setting.

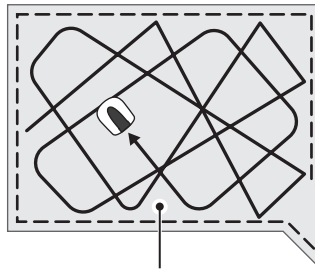

[Directional]

With the **[Directional]** setting, when the lawnmower detects the boundary wire, it turns at a narrow angle. This is used for mowing narrow areas.

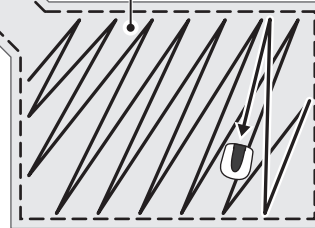

[Mixed]

With the **[Mixed]** setting, the lawnmower alternates between the **[Random]** mowing pattern and the **[Directional]** mowing pattern at regular intervals.

You can adjust how the lawnmower moves while mowing.

With the **[Mixed]** setting, the lawnmower alternates between random mowing and directional mowing in approximately 15-minute intervals.

1

Select **[Random]**, **[Directional]** or **[Mixed]**.

2

Press the **⏪** button.

3

Press the **⏩** button to return to the previous screen.

Menu screen
 Home screen → [2.Garden setup] → [1.Auto mode] →
 [3.Wire overlap]

When the lawnmower detects the boundary wire, it can slightly cross the boundary to mow the outer edges of the mowing area. You can adjust how far it crosses the boundary wire.

Wire overlap: From boundary wire to front of the lawnmower.



1

Enter a value from 20 to 45 (cm).

2

Press the **⏪** button.

 **Home screen** → **Menu screen** → **[2.Garden setup]** → **[1.Auto mode]** → **[4.Edge cutting]**

With this function, you can mow the unmown area along the boundary wire.

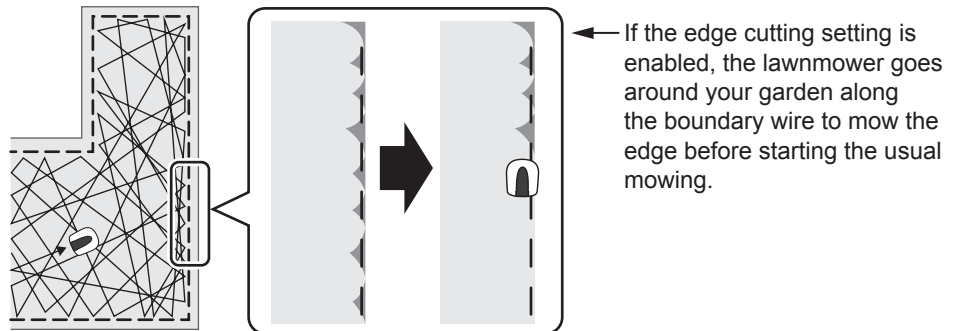

If you set this function on, the lawnmower mows along the boundary wire when the work timer starts for the first time on selected day(s). You can also configure the day(s) of the week on which you want the lawnmower to mow along the boundary wire (2 days per week maximum).

1 Select **[ON]** or **[OFF]** for configuring the edge cutting, and press the **⏪** button. If select **[ON]**, go to step2. The unmown part along the boundary wire will be neatly-mowed. If select **[OFF]**, you will return to the previous screen. You can select **[OFF]** to operate the lawnmower with reduced battery consumption.

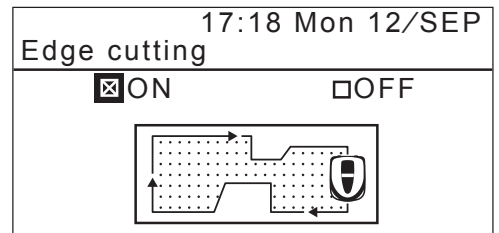

2 Select **[CW]**, **[ACW]**, or **[Mixed]** for the edge cutting direction. Then select **[NEXT]** and press the **⏪** button.
 [CW]: Proceed clockwise
 [ACW]: Proceed anti-clockwise
 [Mixed]: Alternate between CW and ACW

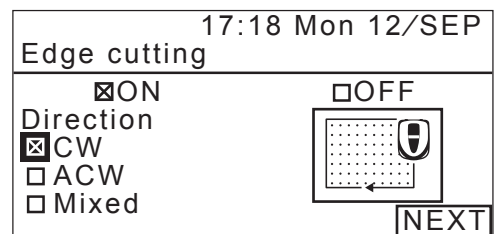

3

Select the day of the week on which you want the lawnmower to run with the edge cutting function, and press the \ominus button. You can select up to two workdays per week.

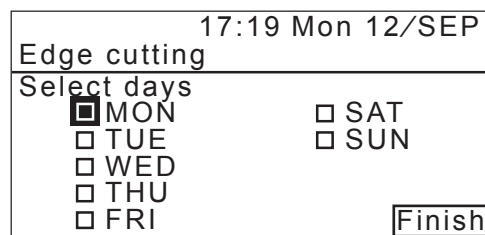

4

Select [Finish] and press the \ominus button.

 Home screen \rightarrow Menu screen \rightarrow [2.Garden setup] \rightarrow [1.Auto mode] \rightarrow [5.Spiral cutting]

With this function, the lawnmower can be focused on mowing the area where the lawn is not completely mown, or the growth speed of the lawn is fast.

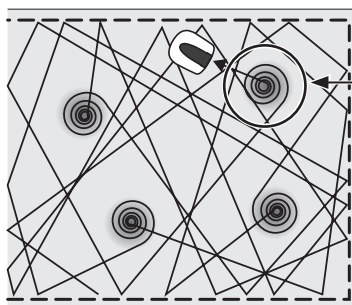

The lawnmower detects the dense area and mow there spirally.

With this function, you can concentrate the lawnmower on mowing the dense area of lawn during the normal operation.

Select [ON] or [OFF] for configuring the spiral cutting, and press the \ominus button. You can select [OFF] to operate the lawnmower with reduced battery consumption.

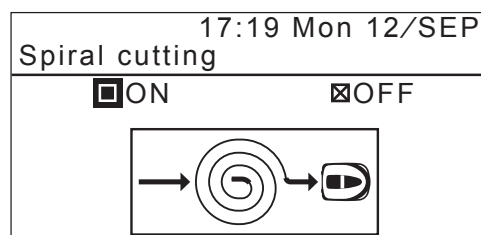

 **Home screen** → **Menu screen** → **[2.Garden setup]** → **[1.Auto mode]** → **[6.Narrow passage]**

If there are narrow passages on your garden, you can configure the settings of the narrow passages to let the lawnmower pass through them toward the starting point.

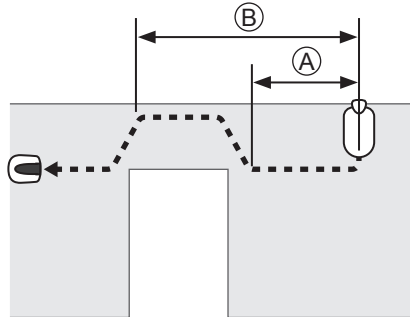

(A) : Distance between the docking station and the start of the narrow passage.







(B) : Distance between the docking station and the end of the narrow passage.

15:45 TUE 23/FEB		
Narrow passage		
	⌚ / ⌚	From - to
1	<input type="checkbox"/> / <input checked="" type="checkbox"/>	10 - 20 m
2	<input checked="" type="checkbox"/> / <input type="checkbox"/>	0 - 0 m
3	<input checked="" type="checkbox"/> / <input type="checkbox"/>	0 - 0 m
4	<input checked="" type="checkbox"/> / <input type="checkbox"/>	0 - 0 m (0 - 750m)

Configure the distance of the narrow passages from the docking station to let the lawnmower pass through them.

NOTE:

- Specify the distance from start to end of each narrow passage from the docking station.
- This setting is for going toward the starting point. If you want to configure the setting for returning to the docking station, you need to set it in the Homing setup. For details, see "Homing setup" (page 48).

- 1 Select a number from 1 to 4 which you want to configure and press the  button.
- 2 Select  or  and press the  button. And enter the values of the distance from start to end of each narrow passage and press the  button.
- 3 Press the  button.
- 4 Press the  button to return to the previous screen.

Manual mode

With this function, you can configure the lawnmower to mow without the work timer function.



NOTE:

- If you want to operate the lawnmower with [Manual mode], see "Operating the lawnmower with the Manual mode" (page 90)

Mowing pattern

You can select from 3 mowing patterns below:

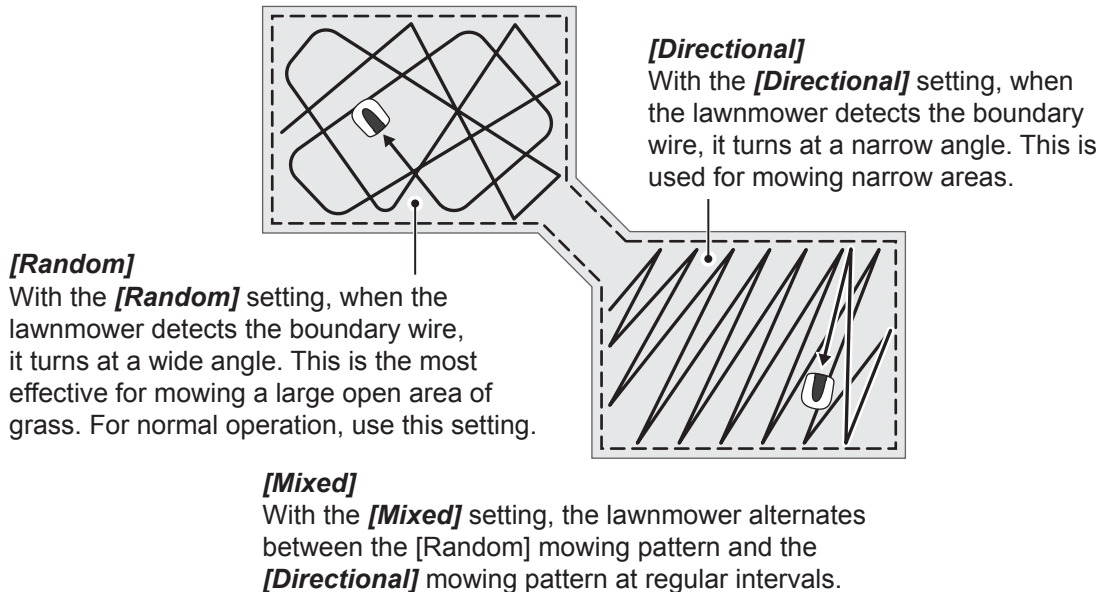

Wire overlap

When the lawnmower detects the boundary wire, it can slightly cross the boundary to mow the outer edges of the mowing area.

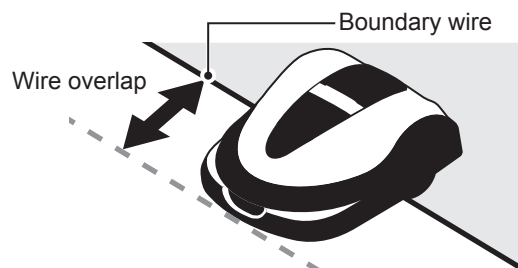

Edge cutting:

With this function, you can mow the unmown area along the boundary wire.

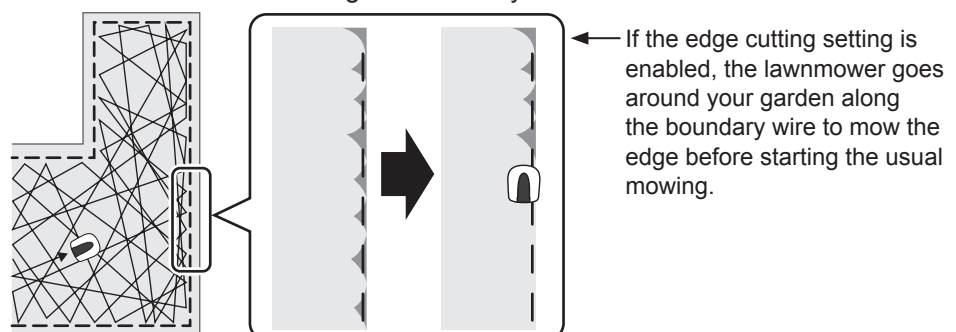

● Spiral cutting:

With this function, the lawnmower can be focused on mowing the area where the lawn is not completely mown, or the growth speed of the lawn is fast.

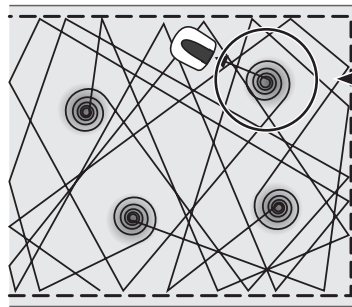

The lawnmower detects the dense area and mow there spirally.







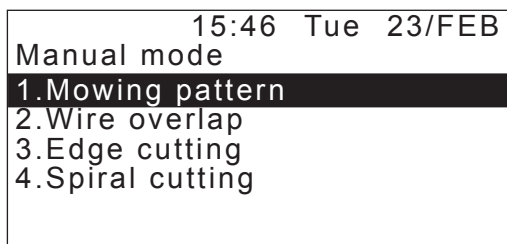

 Home screen → **Menu screen** → [2.Garden setup] → [2.Manual mode]

You can adjust how the lawnmower moves while mowing.

NOTE:

- If you want the lawnmower to operate with the manual mode, change the operating mode by pressing the  button. For details, see “6 USAGE” (▣ page 66).
- Among the mowing pattern settings, the [Mixed] setting is also available. With this setting, the lawnmower alternates between the Random mowing pattern and the Directional mowing pattern at regular intervals.



- 1 Select [1.Mowing pattern] and press the  button.
- 2 Select [Random], [Directional] or [Mixed] for configuring the mowing pattern, and press the  button.
- 3 Select [2.Wire overlap] and enter the values of the wire overlap from 20 to 45, and press the  button.
- 4 Select [3.Edge cutting] and press the  button.
- 5 Select [ON] or [OFF] and press the  button.
If you select [ON], go to step 6.
If you select [OFF], go to step 8.
- 6 Select [CW] or [ACW] and press the  button.
- 7 Select [Finish] and press the  button.
- 8 Select [4.Spiral cutting] and press the  button.
- 9 Select [ON] or [OFF] and press the  button.

■ Garden layout

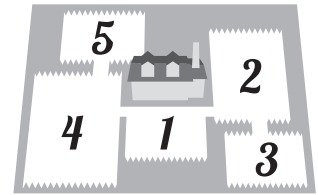

Home screen → ^{Menu screen} [2.Garden setup] → [3.Garden layout] → [1.Docking direction]

You can set the direction for the lawnmower to move in relation to the docking station.

NOTE:

- Before configuring the settings, confirm the completion of installing the docking station and laying boundary wire with your dealer.
- For details on the boundary wire connection of the docking station terminals, see "Installing boundary wire and connecting to the docking station" (page 16).

1

Select the set pattern.

There are 4 installation methods.

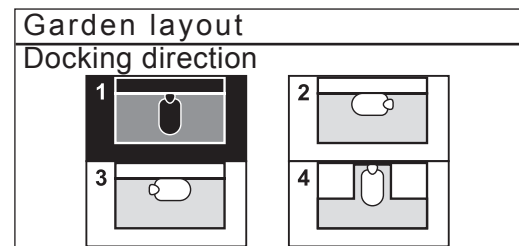

2

Press the button.

Home screen → ^{Menu screen} [2.Garden setup] → [3.Garden layout] → [2.Wire length...]

You can configure the information of your garden layout to operate the lawnmower.

NOTE:

- Before configuring the settings, confirm the completion of installing the docking station and laying boundary wire with your dealer.
- If the DEALER CHECKSHEET at the end of Owner's Manual was already filled out by your dealer, refer to it when configuring the settings.

1

Enter the values of the boundary wire length and garden size.

Garden layout	
Boundary wire length	
<input type="text" value="50m"/>	(50 – 1000m)
Garden size	
<input type="text" value="100m<sup>2</sup>"/>	(100 – 4000m ²)

2

Press the button.

Homing setup



 **Home screen** → Menu screen → **[2.Garden setup]** → **[4.Homing setup]** → **[1.Passage width]**

You can set the minimum and maximum gap between the lawnmower and boundary wire when the lawnmower returns to the docking station along the boundary wire.

By setting this gap, you can prevent ruts from forming because the lawnmower returns home on different routes.

If there is a narrow passage on the way to the docking station or if the docking station is installed in a narrow passage, refer to the table below to determine the values.

(The values in the table are recommended values that are automatically set when a narrow passage is set in the Setup wizard.)

You may also perform a homing test and then change the values provided that the lawnmower can return home.

Recommended passage width for homing setup

Setup level		Passage width
Min	Max	
1	2	1.0 m – 1.2 m
1	2	1.3 m – 1.5 m
1	3	1.6 m – 1.8 m
3	5	1.9 m – 2.1 m
3	6	2.2 m – 2.4 m
3	7	2.5 m – 2.7 m
3	8	2.8 m – 3.0 m
3	10	No setting

If the docking station is installed in a corner, set the Max value of the setup level to 10 or lower. However, you may perform a homing test and then set it to value higher than 10, provided that the lawnmower can return home.

Corner installation example:

If the setup level is inadequate, the lawnmower cannot detect the docking station and the lawnmower may just pass by.

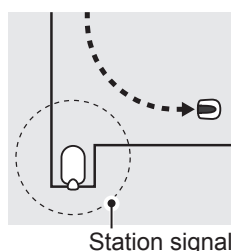

You can input a value from 0 to 15 for the setup level.

Passage width sample table

Setup level	Passage width
0	10 cm
1	25 cm
2	30 cm
3	35 cm
4	40 cm
5	50 cm
6	60 cm
7	70 cm
8	80 cm
9	90 cm
10	100 cm
11	110 cm
12	120 cm
13	130 cm
14	140 cm
15	150 cm

- The field strength varies depending on the length of the boundary wire. The field becomes weaker with a longer boundary wire, and stronger with a shorter boundary wire.
- When the value is high (by avoiding moving along the same path), you can reduce wheel tracks in the grass.
- The numerical values of this table are for reference to return the lawnmower to the docking station along a straight line.
- The numerical values may differ depending on the actual conditions.

TIPS Use as big passage width as possible so to reach the area quickly.

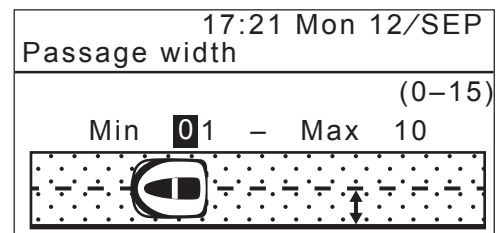

1 Input a value (0 – 15) for [MIN] and [MAX].

2 Press the  button.

 **Home screen** → **Menu screen** → **[2.Garden setup]** → **[4.Homing setup]** → **[2.Capacity for homing]**

You can set the percentage of remaining amount of the battery when the lawnmower starts to go back to the docking station.

TIPS The longer the wire is, the higher this value should be.

1

Select **[Auto]** or Enter a percentage of battery residual capacity.

The range of the percentage of battery residual capacity is 10 – 50%.

17:59 Tue 23/FEB
Capacity for homing
This will decide when the mower will return home.
<input checked="" type="checkbox"/> Auto
<input type="checkbox"/> 10%(10 – 50%)

2

Press the  button.

 **Home screen** → **Menu screen** → **[2.Garden setup]** → **[4.Homing setup]** → **[0.Test return home]**

You can test if the lawnmower will correctly return to the docking station.

NOTE:

- Perform this test when the lawnmower is not connected to the docking station.

TIPS Test returning through the different passages.

1

Select **[Clockwise(CW)]** or **[Anticlockwise(ACW)]**.

Test return home
Select direction to home
Clockwise(CW)
Anticlockwise(ACW)

2

Press the  button.

Confirm the selecting information of the selected direction to home.

3

Close the control panel cover.

The lawnmower returns to the docking station.

4

When the lawnmower is docked at the docking station, press the manual STOP button.

The control panel cover pops up.

The message "Test finished" appears on the display.

■ Cutting height



Home screen → Menu screen → **[2.Garden setup]** → **[5.Cutting height]** → **[1.Auto setup]**

lawnmower will gradually reduce the cutting height from the “start height” to the “target height” that you prefer.

NOTE:

- We recommend that your lawn is cut to a height of less than 65mm before using Miimo.
- If you selected [1.Auto setup], the cutting height will decrease 5 to 20 mm per week. (The speed at which it decreases varies depending on the work load.)
- If lawnmower faces high work load, the cutting height may increase 5mm.
- If lawnmower is turned off for more than 1 week, the cutting height is reset to 60mm.

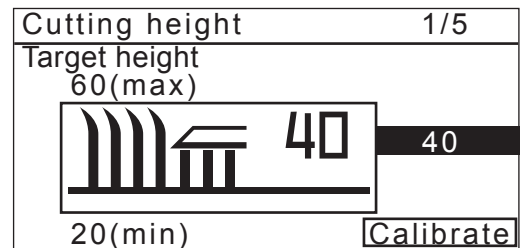
1 Set the “Target cutting height” with the ▲▼ buttons or number buttons and press the ⏪ button.



2 Set the “Start cutting height” with the ▲▼ buttons or number buttons and press the ⏪ button.

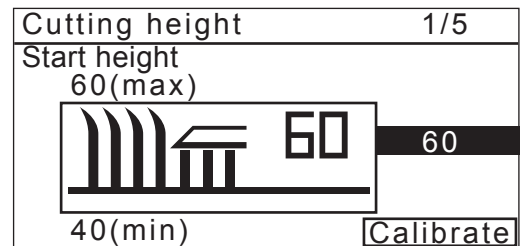

3 When you select [Calibrate] and press the ⏪ button, the blade disc moves to the set cutting height. You can check the cutting height.

- The moved blade disc makes latching sounds at the highest and lowest position, this is normal.

4 Press the ⏩ button, previous screen.



 Home screen → Menu screen → [2.Garden setup] → [5.Cutting height] → [2.Manual setup]

You can configure the cutting height.

NOTE:

- We recommend that you set a height that cuts off 5 mm from the grass height.

1 Set the cutting height with the ▲▼ buttons and press the ⏪ button.

2 When you select [Calibrate] and press the ⏪ button, the blade disc moves to the set cutting height. You can check the cutting height.
 - The moved blade disc makes latching sounds at the highest and lowest position, this is normal.

3 Press the ⏩ button, previous screen.

17:01 Fri 17/APR
Seasonal timer
1.Auto setup
2.Manual setup
Cutting height
35 (20-60)



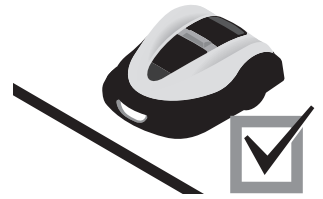

■ Checking the system

■ Check signal

You can check if the boundary wire signal is correctly reaching the lawnmower and confirm how strong the signal is.



 Home screen → ^{Menu screen} **[3.Diagnostics]** → **[1.Check signal]**

Signal level indication	Signal strength
Lv0	No loop signal
Lv1	Weak
	
Lv5	Moderate
	
Lv10	Strong

■ Test start points

You can check whether the lawnmower can correctly return to the docking station, and whether it can reach each start points according to settings.

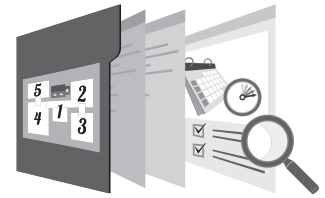

 **Home screen** → ^{Menu screen} **[3.Diagnostics]** → **[2.Test start points]** → **[1.Point1] to [5.Point5]**

You can configure 5 start points.

NOTE:

- Perform this test when the lawnmower is connected to the docking station.

1

Select a point from 1 to 5 which you want to test and press the  button.

2

Confirm the value of the selected point settings.

3

Close the control panel cover.

The lawnmower starts to the selected start point.
When the test is correctly finished, the lawnmower rolls slowly from side to side showing the minimum and maximum exit angle, and a beep sound is emitted from the lawnmower.

4

Press the manual STOP button.

The control panel cover pops up.
The message "Do you want to modify the start point?" appears on the display.

5

Select [Yes] or [No] to the question and press button.

If you select [Yes], Mowing start point screen appears. You can modify the settings of the tested start point.
If you select [No], the previous screen appears.

NOTE:

- For details on the start point settings, see "Setting the mowing start points" ( page 23).



Home screen → Menu screen → **[3.Diagnostics]** → **[2.Test start points]** → **[0.Home]**

You can test if the lawnmower will correctly return to the docking station.

NOTE:

- Perform this test when the lawnmower is not connected to the docking station.

- 1** Select **[Clockwise(CW)]** or **[Anticlockwise(ACW)]**.
- 2** Press the **⊖** button.
Confirm the selecting information of the selected direction to home.
- 3** Close the control panel cover.
The lawnmower returns to the docking station.
- 4** When the lawnmower is docked at the docking station, press the manual **STOP** button.
The control panel cover pops up.
The message "Test finished" appears on the display.

NOTE:

- For details on the homing settings, see "Homing setup" (☞ page 48).

Viewing history

Operation history

You can check the cumulative time that the lawnmower has operated and recharged.

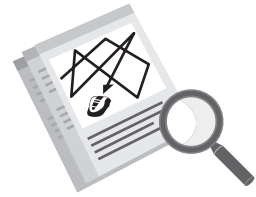

Home screen → ^{Menu screen} [4.History] → [1.Operating history] → [1.Operating time]

You can view how long the lawnmower has mowed, and how long the lawnmower has charged.

1

Check the history.

2

Press the ⏪ button to return to the previous screen.

	15:41 Wed 24/FEB
	Operating time
This is the total cutting time. →	Cutting 180h55min
This is the total charging time. →	Charging 140h37min

Work history

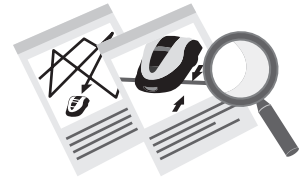

Home screen → ^{Menu screen} [4.History] → [1.Operating history] → [2.Work history]

You can view the lawnmower's cutting history (when the lawnmower was mowing), return history (when the lawnmower was returning to the docking station), and charge history (when the lawnmower was charging).

- 1 Check the history by pressing the ▲▼ down buttons to scroll the menu.
- 2 Press the ⏪ button to return to the previous screen.

NOTE:

- Only the history of auto mode is displayed.

Each time indicates how long the lawnmower was mowing (time when the blades were rotating). The most recent entry is [01], and the oldest entry is [10].

This displays the time taken to return to the docking station after mowing is finished. A new entry is added to the history list every time the lawnmower returns.

The time for the most recent charge history entry is displayed first.

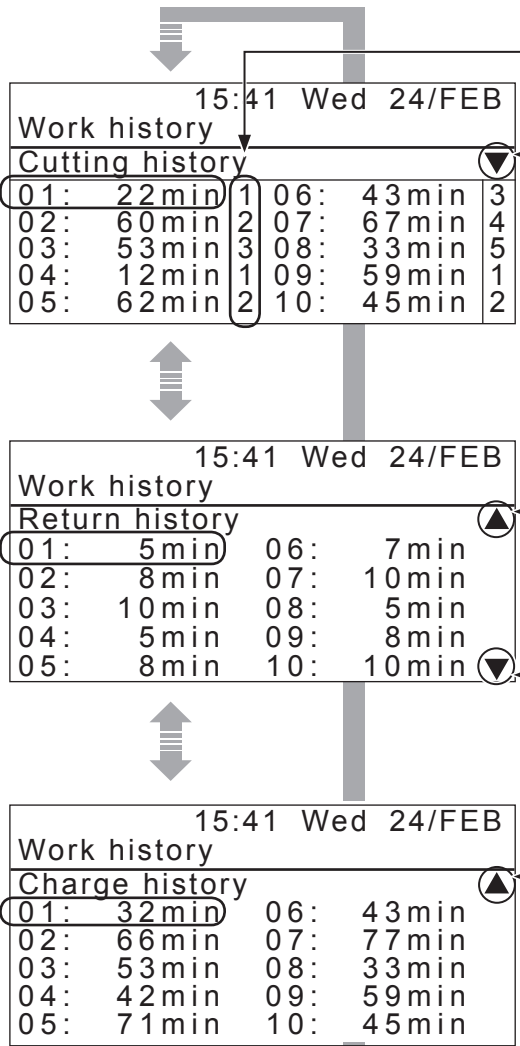

The start point number where the lawnmower was mowing is displayed.

This mark indicates that there is another page. Use the ▲▼ buttons to change pages.

Fault history

You can view the lawnmower's fault history (when a fault occurred).

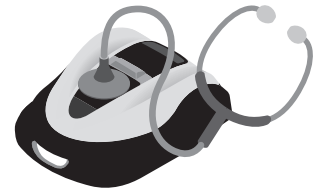

Home screen → **Menu screen** → [4.History] → [2.Fault history]

The history of errors that have occurred are logged.

NOTE:

- If the same error occurs repeatedly many times on the same day, only the time when the first error occurred is saved.

1

Select fault history entry by using the ▲ ▼ buttons.

2

Press the ⏪ button. Fault information is displayed. For details on faults, see "7 TROUBLESHOOTING" (p page 74).

3

Press the ⏩ button to return to the previous screen.

The most recent fault error entry is displayed first. Press the ⏪ button for more information.

	13:33	Fri	15/JUL
Fault history			
1.3A127	15.07.16	13:31	
2.3A122	15.07.16	13:23	
3.3A111	15.07.16	13:23	
4.3A136	15.07.16	13:17	
5.3A136	15.07.16	10:01	
6.3A136	15.07.16	10:00	

This mark indicates that there is another page. Use the ▲ ▼ buttons to change pages.

Fault information and the time of the fault are displayed.

	13:33	Fri	15/JUL
Fault history			
01:Cutting height error			
Caution			
15.07.2016 13:31			

Setting the system

Language

You can set the menus of the display to your preferred language.



 **Home screen** → ^{Menu screen} **[5.System settings]** → **[1.Language]**

Select the language shown in the display from among 12 languages.

1

Select your preferred language.

2

Press the  button.

3

Press the  button to return to the previous screen.

Display/Sound



 **Home screen** → ^{Menu screen} **[5.System settings]** → **[2.Display/Sound]** → **[Contrast]**

You can set the contrast of the control panel display.

1

Change the contrast level by pressing the   buttons.

2

Press the  button.

3

Press the  button to return to the previous screen.

 **Home screen** → ^{Menu screen} **[5.System settings]** → **[2.Display/Sound]** → **[BG color]**

You can set the background color of the control panel display.

1

Select [White] or [Black] by pressing the   buttons.

2

Press the  button.

3

Press the  button to return to the previous screen.

 Home screen → ^{Menu screen} [5. System settings] → [2. Display/Sound] → [Keypad]

You can set whether or not a beep sound is emitted when you press control panel buttons.

1

Select [ON] or [OFF] by pressing the ▲ ▼ buttons.

2

Press the ← button.

3

Press the ↻ button to return to the previous screen.

■ Date and Time

You can set the internal date and time for the lawnmower.



 Home screen → ^{Menu screen} [5. System settings] → [3. Date and Time]

Set the date and time for the lawnmower. The timer operates based on this date and time setting.

1

Enter the date with the format {Day}/ {Month}/ {Year} and the time in 24-hour format using the number buttons.

2

Press the ← button.

3

Press the ↻ button to return to the previous screen.

Security

Security settings are used to prevent the lawnmower from being operated by other people.



 **Home screen** → Menu screen → **[5.System settings]** → **[4.Security]** → **[1.Alarm]**

NOTE:

- Before selecting [1.Alarm], you will need to input your PIN. If you forget your PIN, contact your dealer.

This setting enables or disables the alarm. When set to [OFF], all alarms other than the alarm before the blades start moving are disabled.

NOTE:

- The [OFF] setting also disables the security alarm that is triggered when the incorrect PIN (Personal Identification Number) is entered 3 times in a row.

1

Select [ON] or [OFF] by pressing the ▲ ▼ buttons.

2

Press the ← button.

3

Press the ⏪ button to return to the previous screen.

 **Home screen** → Menu screen → **[5.System settings]** → **[4.Security]** → **[2.Create a PIN]**

NOTE:

- Before selecting [2.Create a PIN], you will need to input your PIN. If you forget your PIN, contact your dealer.

You can modify the PIN used for unlocking the control panel menus. Make sure to create the PIN to prevent theft of the lawnmower, unauthorized access, etc.

1

Input a new PIN using the number buttons.

2

Press the ← button.
The message "Activated" is displayed.

3

Press the ⏪ button to return to the previous screen.

NOTE:

- Write down your PIN in the space provided. See "DEALER CHECKSHEET" (☞ page 100).

Reset

You can reset all settings to the factory defaults.

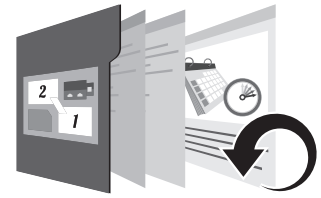

Home screen → ^{Menu screen} [5.System settings] → [5.Reset] → [1.Factory reset]

Execute this command to revert all settings to their factory defaults.

NOTE:

- This command will not reset the history of the lawnmower (working and fault history). This only resets the settings of the lawnmower.
- Consult your dealer before executing this command.
- Dealer settings will be lost after this command.

1

Input your PIN and press the button.

2

Select [Yes].

3

Press the button.

After the message “Activated” is displayed, the power turns off.

Home screen → ^{Menu screen} [5.System settings] → [5.Reset] → [2.Restore dealer settings]

Reset to the settings configured by the dealer.

NOTE:

- This command will not reset the history of the lawnmower (working and fault history). This only resets the settings of the lawnmower.
- Consult your dealer before executing this command.

1

Select [Yes].

2

Press the button.

After the message “Finished” is displayed.

Help

You can get the information of the lawnmower such as the model name, frame serial number, and software version.



Home screen → ^{Menu screen} **Press and hold number button “0”**

This is the software version.

Help		11:04 Wed 24/FEB
Honda Power Equipment		
Miimo	:HRM3000	← This is the model name.
	:MBEF-1000001	← This is the frame serial number.
Software version		
Main ECU	:1.0.0	
Display ECU	:1.0.0	

NOTE:

- If the Frame number is “0000000”, contact your dealer.

5 Mii-monitor Preparation

About Mii-monitor

Mii-monitor is a smartphone/tablet application for the HRM3000. It communicates with the HRM3000 via Bluetooth®.

For operation, use a smartphone that can access the internet.

NOTE:

- The images in this manual are for visual reference only. They may differ from the actual product.
- The features, screens, design, etc. in this manual may be subject to change without notice.
- The operation methods (screens, procedures) in this manual are examples. They may differ depending on your smartphone model.



Mii-monitor features

- Settings identical to the lawnmower control panel
- Remote control operation
- Backup and reset your settings on the Honda server
- Send trouble reports to your dealer if there is an error

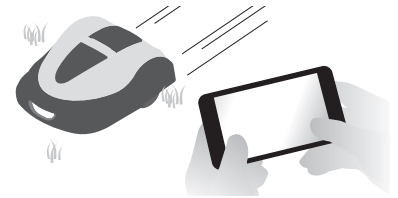

Learn more about Mii-monitor

For more information about how to operate Mii-monitor and supported smartphone/tablet models, please refer to the Mii-monitor Operation Guide (online manual).

To find it, please visit www.hpsv.com/link/OM000231HME/



Installing Mii-monitor

Scan the QR code to download Mii-monitor.

Data charges may apply when downloading the application.

App Store®



Google Play™



Pairing a device (connecting via Bluetooth®)

- It is not possible to connect more than one userid to the same lawnmower. If you want to connect more than one smartphone/tablet to your lawnmower, the same userid must be used on all devices.
- To operate the lawnmower with Mii-monitor, you must pair it with a smartphone/tablet.
- To pair the lawnmower, Initial Settings on the lawnmower must be completed.
- Bluetooth® is a short-range communication technology. It is operable within a distance of about 3 m.

1 Press the **1** (On) button on the control panel.

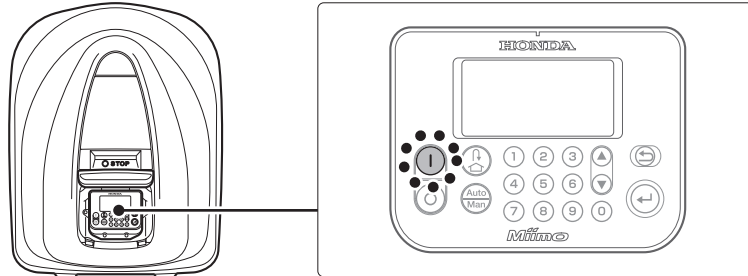

2 Turn on Bluetooth® in the smartphone.

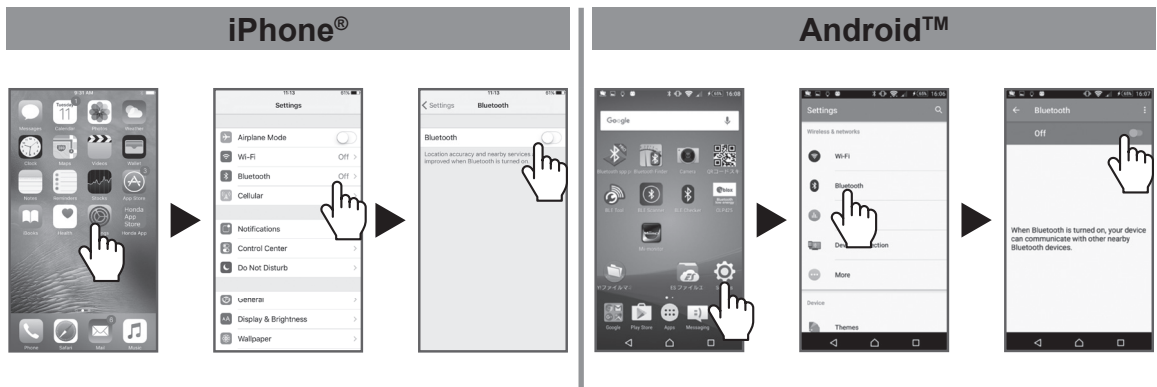

3 After a while, the search results are displayed. Tap the serial number of the lawnmower you want to connect (see page 9).

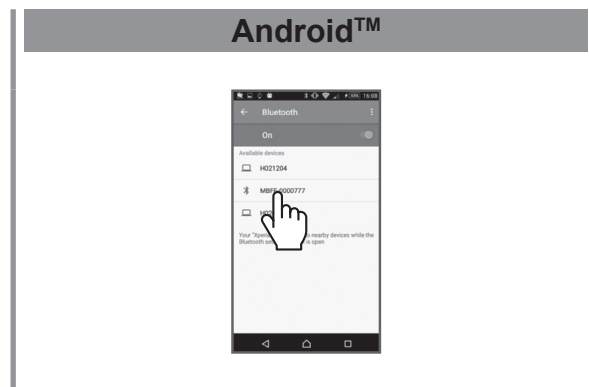

If the serial number of the lawnmower is not displayed, the Bluetooth® of the lawnmower or smartphone may have frozen. Turn off the lawnmower, turn off Bluetooth® in the smartphone, restart, and then try again.

Registering a user

1

Tap [New Registration] in the login screen.

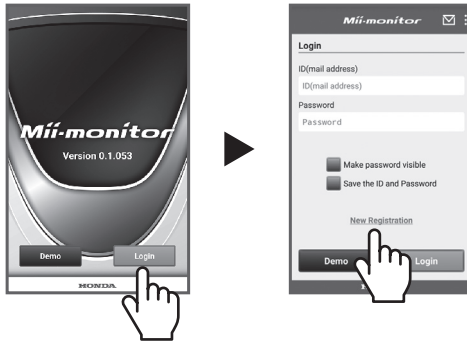

5

Input a password.

- There is no limit to the number of characters.

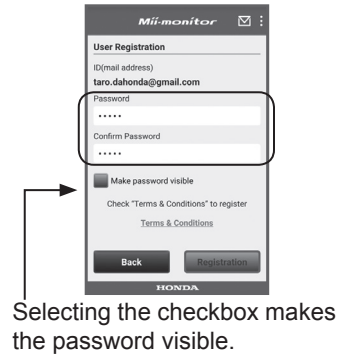

Selecting the checkbox makes the password visible.

2

Register a Serial Number (see page 9).

QR code

Manual input

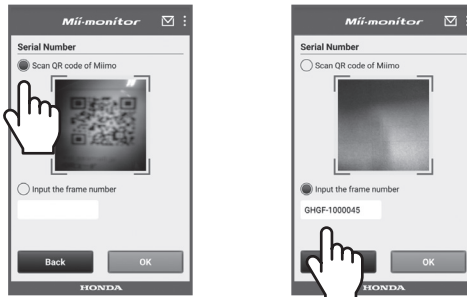

6

Tap [Term & Conditions] and confirm the content. If you agree, tap [Agree].

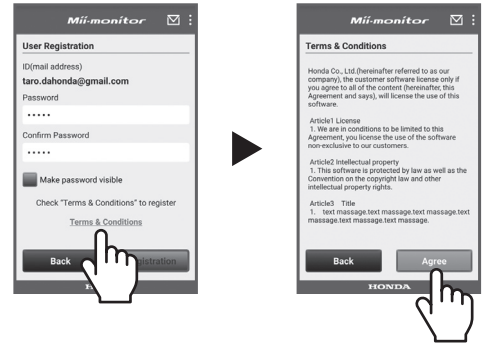

3

Check that the input is correct.

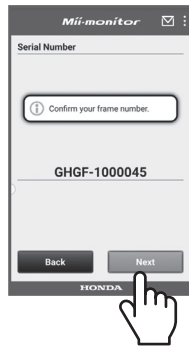

7

Tap [Registration] to send the inputted information to the Honda server.

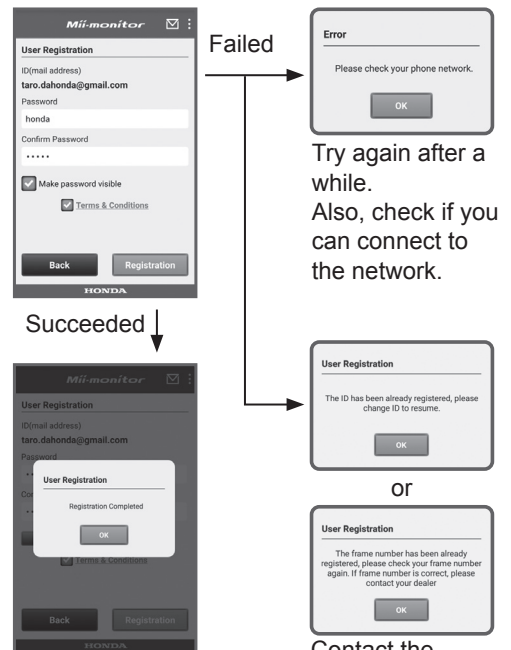

Try again after a while. Also, check if you can connect to the network.

Contact the dealer where you purchased the lawnmower.

4

Input [User Information]. Fields with the * mark are required.



Menu display after connecting to a device

If there is a nearby smartphone that can be connected when you press STOP button, the following screen is displayed.

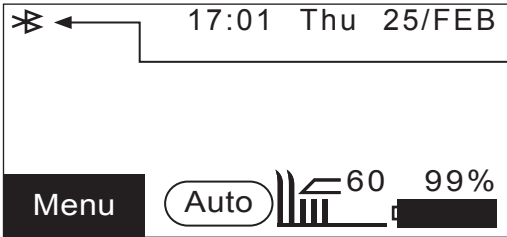
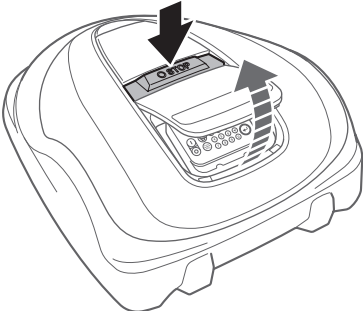

Displayed if a device is available for connection.

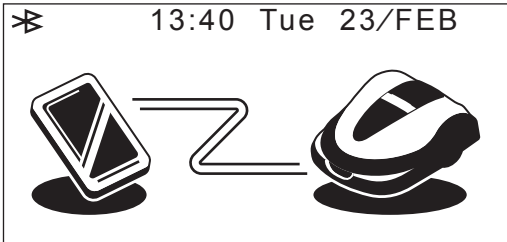

Displayed during remote control.

6 USAGE

Checking the mowing area

Before operating the lawnmower, ensure the mowing area is free of pets and foreign objects.

Turn off the lawnmower before removing any foreign objects.

CAUTION:

- If there are any holes (such as rabbit holes, etc.) in the work area, fill them in so that the work area is level. Periodically check the work area for holes.



Also confirm that the height of the grass is 65 mm or less.

NOTE:

- Adjust the height of the blades to mow the grass within 5 mm. For details on how to adjust the height of the blades, see "Setting the height of the blades" (page 70).

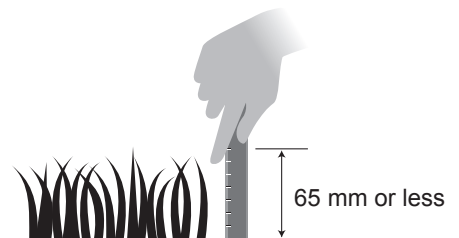

If the grass is taller than 65 mm, cut the grass using a standard lawnmower.

Connecting to a power source

Follow the steps below when connecting to a power source.

Follow these steps in reverse when disconnecting from a power source.

For details on moving the AC adapter or changing to a different power outlet, contact your dealer.

NOTE:

- Connect the station only to a supply circuit protected by a residual current device (RCD) with a tripping current of not more than 30 mA.

1

Remove the station cover from the docking station.

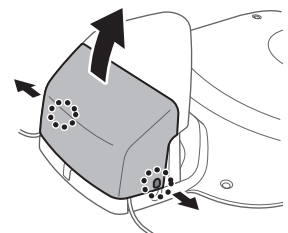

2

If the power cord of the AC adapter is not long enough, connect the extension cord.

Connect the power cord connector to the station's internal connector.

NOTE:

- When disconnecting the connectors, make sure to lift the clip.
- When the length of the cord is not enough even if you use an extension cord, extend the power outlet (House) side.

Power outlet (House) side

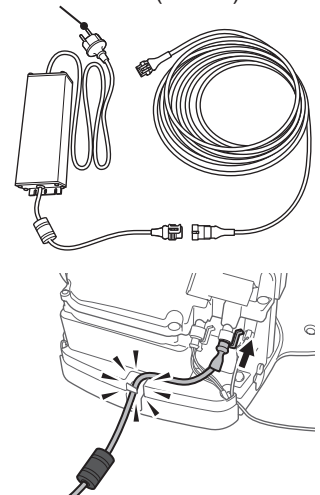

3

Attach the station cover to the docking station.

CAUTION:

Do not secure the power cord with the pegs used to secure the boundary wire. Doing so may damage the power cord.

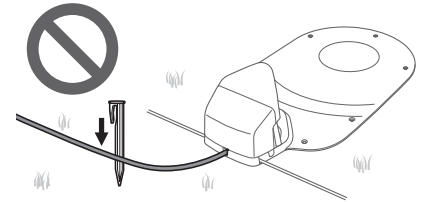

4

Connect the AC adapter plug to a power outlet with the designated voltage.

Power outlet voltage for the E and S types: AC 230 V
Power outlet voltage for the B type: AC 240 V

Checking the lawnmower

Before operation, check to make sure that it is connected all the way into the docking station.

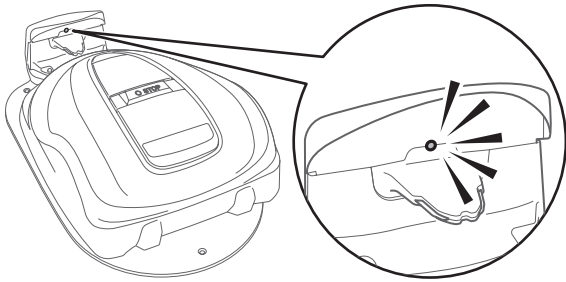

The light above the charging plug changes as follows:

Color	Description
Green	The docking station signal setting is correct.
Green (blinking)	The boundary wire is too long.
Amber	The lawnmower is correctly connected to the docking station.
Amber (blinking)	A signal problem—such as the boundary wire becoming disconnected or cut—has occurred. Contact your dealer.
Red (blinking)	A station signal problem—such as the station wire becoming disconnected or cut—has occurred. Contact your dealer.
Red	The docking station is fault. Check the connectors (see page 83). Contact your dealer.
Off	Confirm the connection with the power cord. If the docking station is correctly connected with the power cord, a power failure has occurred. Contact your dealer.

CAUTION:

- Do not touch the recharging connector. If you touch it, you may become injured.

Turning on / off the power

Turning on the power

After the battery is charged, press the ⏻ (On) button to turn on the lawnmower.

The ⏻ (On) button is located on the control panel at the rear side of the lawnmower.

⚠ WARNING

- When stopping the lawnmower, approach it from the back. Approaching it from the front or sides may lead to unintended contact with the lawnmower, and you may fall over it when the lawnmower begins to move.

1

Press the manual STOP button.
The control panel cover pops up.

2

Press the (On) button on the control panel.

The power turns on, and the startup screen on the control panel is displayed.

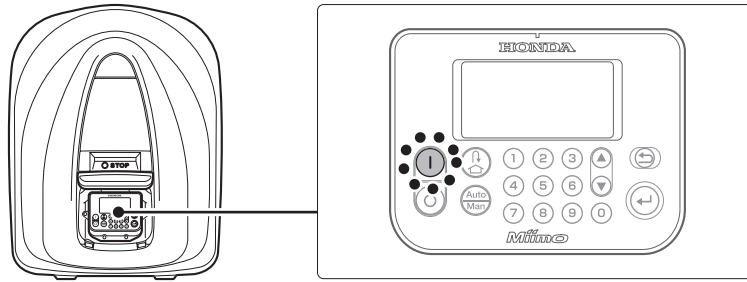

● Entering your PIN (Personal Identification Number)

When turning the lawnmower on, you must enter the PIN.

1

Enter the PIN using the number buttons.

NOTE:

- To change the PIN, see “4 MENU SETTINGS” (☞ page 32).



2

Press the (Home) button.

The home screen is displayed.

NOTE:

- If you input an incorrect PIN 3 times in a row, the control panel is locked for 5 minutes, during which time you cannot perform operations.
- If you forget the PIN, consult your dealer.
- If an error message is displayed, see “7 TROUBLESHOOTING” (☞ page 74).

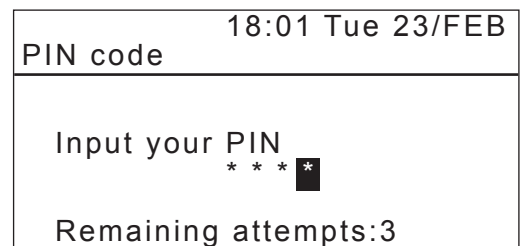

● Turning off the power

1

Press the manual STOP button.

The control panel cover pops up.

2

Press the (Off) button on the control panel.

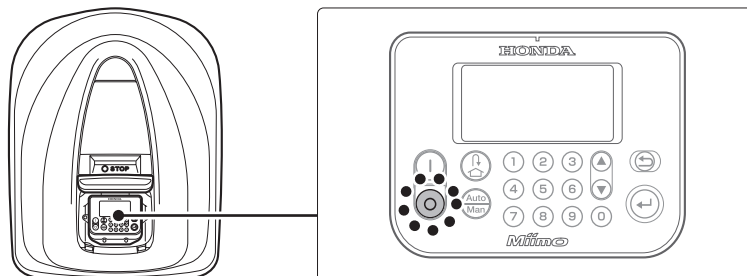

NOTE:

- When you turn off the lawnmower, it will not begin to operate even if you set the timer.

Operating the lawnmower in Auto mode

These instructions can be used to operate the lawnmower at the time scheduled for the Auto mode settings.

NOTE:

- For details on settings, see “4 MENU SETTINGS” (☞ page 32).

▲ WARNING

- Make sure to press the manual STOP button before performing the following procedure.

1 Press the  button.

2 If the [Auto] is displayed on the Home screen, go to step 3.
If the [Man] is displayed on the Home screen, press the  (Auto / Manual) button until the [Auto] is displayed.

For details on the icons in the screen, see “Home screen” (☞ page 11).

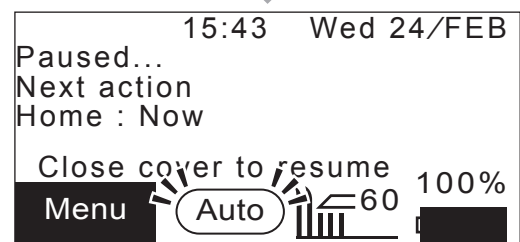
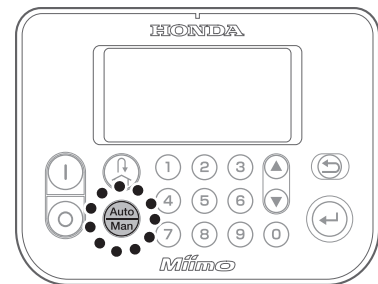

3 Close the control panel cover.

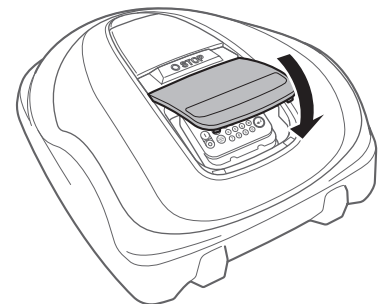

Setting is now complete. The lawnmower starts mowing at the time scheduled for the Auto mode. For details on settings, see “4 MENU SETTINGS” (☞ page 32).

NOTE:

- If you press the  (Off) button after configuring these settings, the lawnmower will not activate.

Setting the height of the blades

The height of the blades determines how tall or short the grass will be cut.
Test the lawnmower on a small area and adjust blade height according to your preference.



⚠ WARNING

- Make sure to press the manual STOP button before performing the following procedure.

● Auto setup

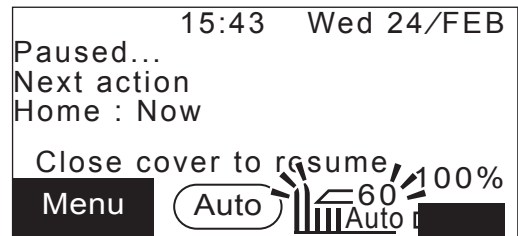
1 Select  in the Top screen and press the  button.



2 Set the "Target cutting height" with the   buttons and press the  button.

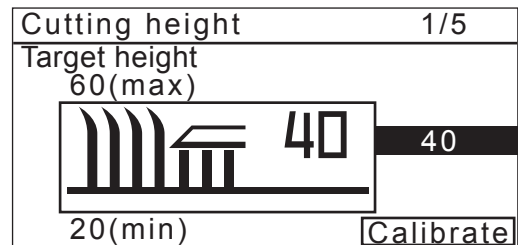

3 Set the "Start cutting height" with the   buttons and press the  button.

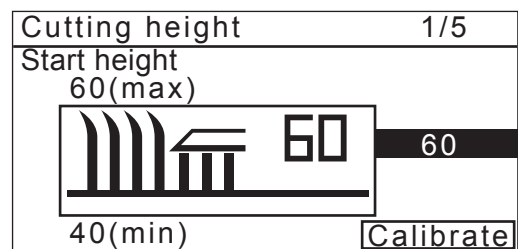

4 When you select [Calibrate] and press the  button, the blade disc moves to the set cutting height. You can check the cutting height.
- The moved blade disc makes latching sounds at the highest and lowest position, this is normal behaviour.

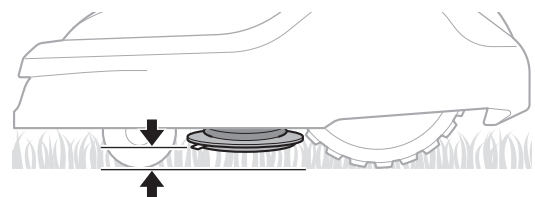

5 If you press the  button, the Top screen.



● Manual setup

CAUTION:

- Avoid cutting too much at once. Mow gradually step by step.
- Avoid cutting more than 5 mm of grass at once. If you want to cut more than 5 mm, it should be done gradually in steps of 5 mm maximum per week. Example: decreasing from 50 to 30 mm should require 4 weeks with 5 mm steps.

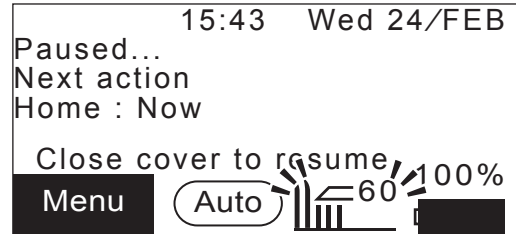
1 Select  in the Top screen and press the  button.



2 Check that the setting value (20 – 60) of the cutting height is selected and press the  button.
- You can select the setting value (20 – 60) or [Calibrate] with the   buttons.

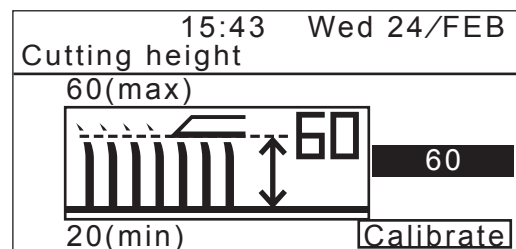

3 Set the cutting height with the   buttons and press the  button.

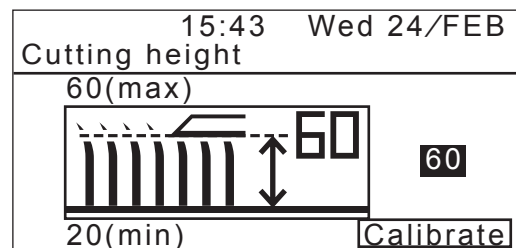

4 When you select [Calibrate] and press the  button, the blade disc moves to the set cutting height. You can check the cutting height.
- The moved blade disc makes latching sounds at the highest and lowest position, this is normal behaviour.

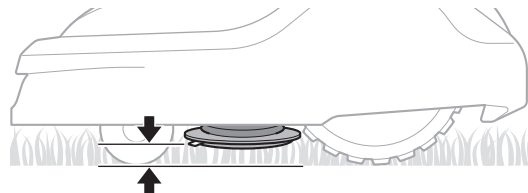

5 If you press the  button, the Top screen.

Weekly checks

Check the lawnmower and docking station once a week to remove dirt and grass. Also check if the blades and blade disc have been damaged, and verify that there are no other problems.

● **Cleaning the lawnmower and docking station**

Dirt and grass may accumulate on the top and bottom of the lawnmower, docking station, and charging plug during and after mowing.

For details on how to clean the lawnmower, see “8 MAINTENANCE” (☞ page 79).

● **Checking the blades and blade disc for problems**

The blades and blade disc may become damaged while mowing. Make sure to perform weekly checks of the blades and blade disc.

For details on how to check the blades and blade disc, see “8 MAINTENANCE” (☞ page 79).

Carrying the lawnmower

When carrying the lawnmower, observe the following points.

⚠ WARNING

- Do not carry the lawnmower with the blades pointed toward you.
- Take care to avoid dropping the lawnmower when carrying it.
- Make sure to press the manual STOP button and press the Ⓞ (Off) button to turn the power off before performing the following procedure.
- Make sure the lawnmower (especially the blades) does not touch anyone when you are carrying it.

1. Press the manual STOP button to open the control panel cover, and press the Ⓞ (Off) button.
2. Close the control panel cover.
3. Pick up the lawnmower by the carrying area.

Lift the lawnmower with one hand from the rear side with the blades pointed away from you.

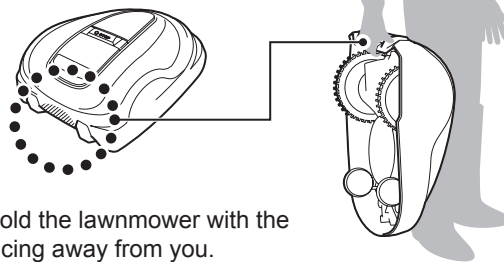

Always hold the lawnmower with the blades facing away from you.

CAUTION:

- When carrying the lawnmower, make sure to carry it by carrying area at the lower rear of the lawnmower. If carrying it by any other area, you may be injured by the blades or charging socket area of the lawnmower, or the lawnmower may fall and become damaged.
- Do not lift or carry the lawnmower by holding it from the opening in the front.
- Do not carry the lawnmower while it is attached to the docking station. The lawnmower and docking station may be damaged.

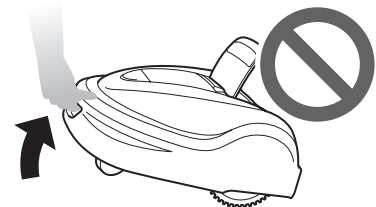

- You can use the remote control feature of Mii-monitor to move the lawnmower. When using remote control, follow the precautions below.
 - Operate in a brightly-lit area
 - Avoid operating on wet grass
 - Thoroughly watch your footing on inclines
 - Do not forcefully connect the lawnmower to the docking station using remote control. The docking station may get damaged.



7 TROUBLESHOOTING

Before contacting your dealer

In the unlikely event that you are facing a problem and you need to contact your dealer, ensure that you have the following information available.

- Owner's Manual
- Consider any recent work in your garden.
- [Fault history] information

 **Home screen** → **Menu screen** → **[4.History]** → **[2.Fault history]**

Mii-monitor has an option to send trouble reports to your dealer. If the problem is not resolved even after referring to the following troubleshooting guide, send a trouble report to your dealer.

 **Top screen** → **≡ (in the upper-right)** → **[Help & Link]** → **[Send to trouble report to dealer]**

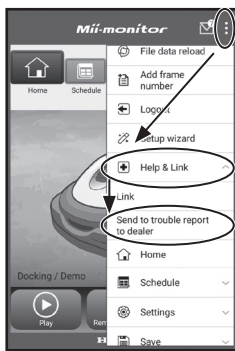

Messages

If any of the following messages appear in the display, use this troubleshooting guide to address the problem before contacting your dealer. If the problem persists, contact your dealer.

Message	Cause	Solution
Area signal lost	The lawnmower does not detect the boundary wire signal.	Check if the boundary wire connectors are correctly connected. If the message does not disappear, contact your dealer.
Battery capacity low	The battery does not charge enough.	Increase the remaining capacity of homing. See "Homing setup" (page 48). If the message does not disappear, contact your dealer.
Battery capacity reduced	The battery does not charge enough.	
Battery temp high	The battery temperature is too high.	Set the power to ON, and wait until the message disappears. If the message does not disappear, contact your dealer.
Battery temp low (1) Battery temp low (2)	The battery temperature is too low.	Put the lawnmower in a place where the temperature 5°C or higher, set the power to ON, and wait until the message disappears. If the message does not disappear, contact your dealer.
Battery voltage high	The battery charges too much.	Remove the lawnmower from the docking station, set the power to ON, and wait until the message disappears. If the message does not disappear, contact your dealer.
Battery voltage low	The battery does not charge enough.	Charge the lawnmower with the docking station. This message disappears if the battery is charged more than 10%. If the message does not disappear, contact your dealer.
Blade motor temp high	The temperature of the blade motor is or exceeds 85°C.	Leave the power ON and the control panel cover open, and wait 15 to 30 minutes until the message disappears. If the message does not disappear, contact your dealer.
Clock reset	The backup battery power has drained during long-term storage. The clock has been reset.	Set the current date and time. The time must be in 24-hour format. If the clock cannot be set, contact your dealer.
ENT key	The Enter button was pressed while the lawnmower was running (with the control panel cover closed).	Open the control panel cover and check if any foreign objects are stuck inside. If this message appears after removing any foreign objects, contact your dealer.
Excessive tilt	The lawnmower is in an excessively tilted area.	Place the lawnmower on a flat surface, and enter the PIN so that the message disappears. If the message does not disappear, contact your dealer.
Key pad	A button was pressed while the lawnmower was running (with the control panel cover closed).	Open the control panel cover and check if any foreign objects are stuck inside. If this message appears after removing any foreign objects, contact your dealer.
Mower lifted	The cover has been lifted by something, e.g. a stone.	Enter the PIN so that the message disappears. If the cover is heavily damaged or the message does not disappear, contact your dealer.
Cutting height error	The height of the blade disc is off.	Refer to "Setting the height of the blades" (page 70) and perform [Calibrate]. If the message does not disappear, contact your dealer.

Message	Cause	Solution
No boundary signal	The lawnmower does not detect the boundary wire signal.	Check if the boundary wire connectors are correctly connected. Check a power supply of docking station. See "Test start points" (☞ page 53). If the message does not disappear, contact your dealer.
Obstruction detection	An obstruction is being detected.	Enter the PIN so that the message disappears. If the message does not disappear, contact your dealer.
Obstruction sensor	Obstruction sensor is inactive, or there is an object interrupting the sensor.	Fully move the main cover in order to check sensors can be activated. Shake : Not possible to recover Turn off : Not possible to recover If "Obstruction sensor" message remains, check around and underneath the cover for any objects like chips, dust or small toys, then remove it, or contact your dealer.
Outside loop	The lawnmower exited the boundary wire.	Move the lawnmower into the work area. Check the power supply of the docking station. Check if the boundary wire connectors are correctly connected. If the message does not disappear, check if the boundary wire connectors are correctly connected, and check if there are no similar lawnmowers in the area or any electronic device or electrical installation that could interfere with the lawnmower signal. If the message still does not disappear, contact your dealer.
Upside down	The lawnmower is upside down.	Place the lawnmower on a flat surface, and enter the PIN so that the message disappears. If the message does not disappear, contact your dealer.
Mower was turned off	Lawnmower has been off for one week or longer while using automatic cutting height adjustment or automatic seasonal timer.	Check if there are abnormalities or changes with the condition of the lawn before resuming operation.
Work load is too high	The cutting height was increased due to detection of a high work load while using automatic cutting height adjustment.	Check the following conditions and resume operation. <ul style="list-style-type: none"> • The blades are worn out. • Dirt and cut grass have accumulated in the working parts such as the blade disc. • The work timer has not been set for a long enough period to mow the entire lawn. • There are obstacles such as branches and rocks on the lawn.
Work load is too high	Operation cannot continue due to detection of a continuous high work load.	Check the following conditions and resume operation. <ul style="list-style-type: none"> • The blades are worn out. • Dirt and cut grass have accumulated in the working parts such as the blade disc. • The work timer has not been set for a long enough period to mow the entire lawn. • There are obstacles such as branches and rocks on the lawn. If none of the above applies, contact your dealer.
Contact your dealer if the following messages have appeared.		
Area sensor Battery Error Battery temperature Blade motor Blade motor blocked Blade motor relay Bluetooth communication error Charging control	Clock Communication Error Data memory Error Display Unit Error Lift sensor Manual stop Motor ECU Error Motor sensor Blade	Motor sensor L Motor sensor R Rollover sensor Tilt sensor Wheel motor Wheel motor blocked Yaw sensor

It may be necessary to exchange the battery. Contact your dealer with the operating history ready (cutting time, charging time, returning time).

Resolving problems

Unless having the power on is necessary to check something, turn off the power when checking the condition of the lawnmower or the blade.

Problem	Solution
The lawnmower cannot be charged.	Check the cable connections, confirm that the docking station's LED indicator is on (LED indicator should turn on), check that there are no foreign material in the charging socket that prevent a good electrical connection, and charge the lawnmower again. If the lawnmower still cannot be charged, contact your dealer.
The lawnmower will not enter an area, or the blades and movement have stopped.	The lawnmower will try to evade an area with a slope of more than 20°. In the case of a 25 – 30deg slope (depending on unevenness of the ground) - The lawnmower will try to escape from the slope In the case of a slope more than 30deg slope - The lawnmower will try to evade an area a few seconds and stop due to "Excessive tilt"
The lawnmower stops frequently.	Operation of this product with other wireless devices, remote controls, or electric fences is not guaranteed. Contact your dealer.
The lawnmower leaves the preset area or behaves differently from the settings.	See the error message on the screen and follow the instructions before contacting your dealer. If you cannot solve the issue, contact your dealer with the error messages ready.
The boundary wire has slackened and come out of the ground or a peg has come out of the ground.	Stop the lawnmower because it may cut the wire. Be careful not to trip on the boundary wire or peg. Contact your dealer.
A strange noise is heard from the lawnmower or the lawnmower vibrates.	Check the blades if they are broken or not. Broken blades can create an unbalanced blade disc. It can create noise. Try to use "Quiet timer". Contact your dealer if it cannot be solved.
The lawnmower does not leave the docking station. No error message is displayed.	- Timers were not set up correctly. Check the timer settings. See "4 MENU SETTINGS" (☞ page 32). - The Date and Time are incorrect. Check the clock (☞ page 59). - The manual STOP button was pressed, but the ⏻ button was not pressed before closing the control panel cover. - The lawnmower is in inactive mode. Another cause could be that the machine is in "Home" mode. - The lawnmower in the Auto mode will always charge the battery up to 100%. If you want to make the lawnmower to start mowing sooner, change the operating mode to the Manual mode.
Poor mowing results.	- The cutting height is incorrect or the grass is too high. Adjust the cutting height or cut with a standard lawnmower first if the grass is too high. - Check the condition of the blades (☞ page 86).
The lawnmower does not work inside the boundary wire.	- If there are electromagnetic and electric fields near the boundary wire such as power line, factory, electric noise might affect the movement of your lawnmower. Contact your dealer.
The lawnmower is found stopped, and switched off in the garden.	- A power failure occurred. The lawnmower behaves as follows: In case that the power supply is cut off for more than 30 minutes, the lawnmower will shut off automatically to prevent the battery from becoming empty. In case that the power supply comes back within 30 minutes, the lawnmower will start mowing automatically. * * The lawnmower will return to the docking station if the battery residual capacity is low.
The lawnmower goes out of the boundary wire.	Record where the lawnmower goes out of wire. Check the ground condition, weather condition and tyre condition when the lawnmower goes out of the boundary wire. Clean up the tyre if it has any mud, leaves, or grass. Try to continue. If the issue occurs frequently, contact your dealer.
The lawnmower does not dock into the docking station.	Check station condition if it deformed or not. Check boundary wire underneath the station (☞ page 12). Clean up the charging socket of both the lawnmower and station.

Problem	Solution
Noticeable wheel tracks.	Try to reduce the work timer. You can reduce the work timer automatically by using "Seasonal timer". Try to increase "passage width".
The lawnmower does not enter narrow corridors.	Check the "passage width" setting. If necessary, you can use the "Narrow passage" function (see page 44). Narrow passages cannot be less than 1 m between wires. Secure a width of 1 m or more.
The smartphone cannot connect (pair) with the lawnmower.	<ul style="list-style-type: none"> - Check if the lawnmower is on. When turning it on, wait 5 seconds before connecting. - The smartphone may be too far from the lawnmower. Bring it closer to the lawnmower. - Connecting (pairing) will not succeed if someone is already connected to the lawnmower via Bluetooth®. Do not communicate via Bluetooth® at the same time.
The control panel cover cannot be opened when the manual STOP button was pressed.	Press again near center of manual STOP button. The control panel cover cannot be opened in case of pressing one side of manual STOP button.

8 MAINTENANCE

Periodic inspection and maintenance

The lawnmower must be periodically inspected and maintained for safety and to keep it running at a high level of performance.

Periodic maintenance will also help to extend service life.

The required service intervals and the kind of maintenance to be performed are described in the following chart. Honda recommends annual service to be completed by your local authorised Honda dealer. The dealer will be able to perform a variety of checks and software updates that cannot be completed by the owner.

Maintenance schedule

REGULAR SERVICE PERIOD			Every week	Every year or every 1350h operating hours. (Cutting time)	Page	
Perform at every indicated period or operating hour interval, whichever comes soonest.						
Machine	Blade * & Blade nut *	Check	○		(☞ page 86)	
	Blade disc *	Check	○		(☞ page 86)	
	Motor housing boot	Check or clean	○		(☞ page 85)	
	Charge socket	Check or clean	○		(☞ page 85)	
	Manual stop button	Check		○	(☞ page 81)	
	Body parts *	Clean	○			(☞ page 80)
		Check			○(1)	–
	Traction motor (wheel axles)	Check (grease)			○(1)	–
	Wheels	Check or clean	○			(☞ page 84)
		Replace			If necessary(1)	–
	Caster & bearing	Check or clean	○			(☞ page 84)
		Replace			If necessary(1)	–
	Obstruction sensor (component part)	Check or clean			○(1)	–
		Replace			If necessary(1)	–
Battery condition	Check			○(1), (3)	–	
Breather	Check			○(1)	–	
Sealing	Check			○(1)	–	
Docking station	Docking station	Clean	○		(☞ page 81)	
		Check		○	(☞ page 82)	
	Docking station Screws	Check-Tightness	○(2)		(☞ page 83)	
	Docking station - boundary wire connectors	Check		○	(☞ page 83)	

* Blades, the blade nuts, the blade disc, body parts, the front (caster) wheels, and the rear (drive) wheels should be replaced as needed.

(1) These items should be serviced by your servicing dealer, unless you have the proper tools and are mechanically proficient.

Refer to Honda shop manual for service procedures.

(2) If the screws become loose, tighten them securely.

(3) Confirm using 10 last charges history.

Maintenance procedures

Dirt and grass may accumulate on the top and bottom of the lawnmower during and after mowing, and the blades may become worn, damaged, or unable to turn. Make sure to check the lawnmower according to the chart in “Periodic inspection and maintenance” (☞ page 79).

⚠ WARNING

- Make sure to press the manual STOP button and press the Ⓞ (Off) button to turn the power off before performing the following procedures.
- Put on a pair of work gloves before performing the following procedures.
- Be careful when performing the following procedures, because blades are extremely sharp.

NOTE:

- Remove the lawnmower from the docking station when performing the following procedures.

■ Preparing

- Put on a pair of work gloves.
- When checking the blades, turn the lawnmower on its side.

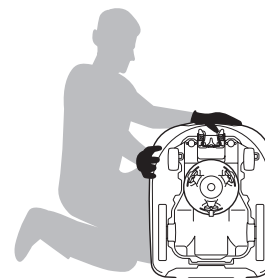

■ Cleaning

▲ WARNING

- Do not touch the blades with your hands.
- Do not lift the lawnmower off of the ground while checking or cleaning it.
- Make sure to press the manual STOP button and press the ⓪ (Off) button to turn the power off before performing the following procedures.

You can wash the lawnmower using a car washing hose or garden hose.

CAUTION:

- Never use an industrial high-pressure washer or household high-pressure car washer.
- Never spray the docking station with water (from a car washing hose or garden hose).

● Cleaning the body (Exterior)

Clean dirt and grass off of the lawnmower using a plastic brush and cloth.

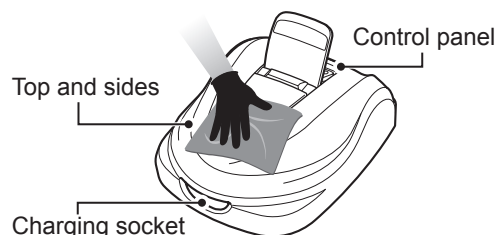

● Removing the grass clippings

To remove the grass clippings from the underside of the lawnmower. Set the cutting height to 20 mm (☞ page 70). Raise the front of the lawnmower and lean it against a wall (at about 90°). Make sure that is no damage (tears, scratches, etc) to the motor housing boots, and then spray the underside with water. You may also use a plastic brush and cloth.

CAUTION:

- Never use a scraper. The scraper may cause damage to the rubber boots on the underside of the lawnmower.
- Do not clean (spray wash) using any detergents or waxes, including mild detergents and automotive cleaners.

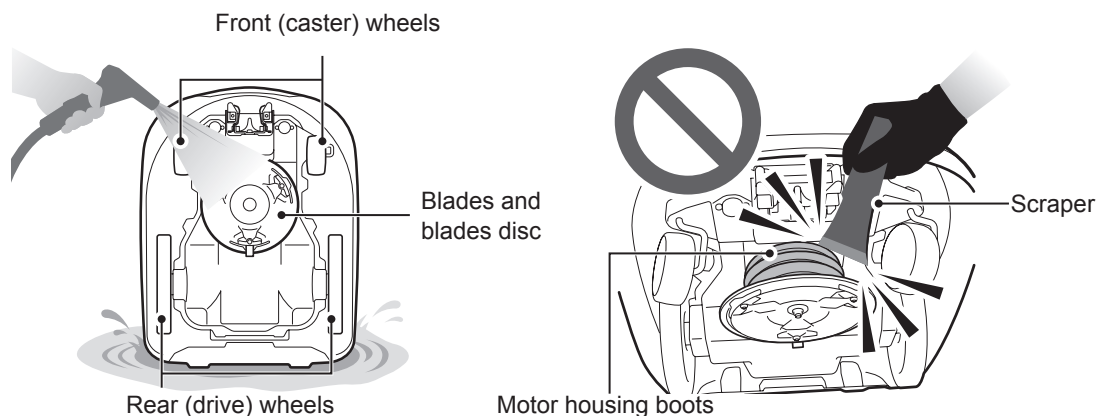

● Cleaning the docking station

▲ WARNING

- Unplug the AC adapter's plug from the power outlet (House) before cleaning it.

NOTE:

- Do not wash the docking station with water. The docking station may be damaged.

Clean dirt and grass off of the docking station using a plastic brush.

Brush off dirt and grass from docking station, particularly around parts on which the lawnmower rests and around the charging plug area:

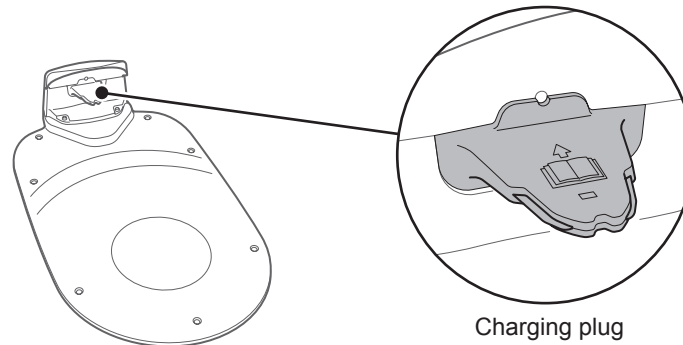

■ Checking

● Checking the manual STOP button

▲ WARNING

- Do not touch the blades with your hands.
- Do not lift the lawnmower off of the ground while checking or cleaning it.

Check item(s)		Action
Manual STOP button and control panel cover	Normal operation of the manual STOP button (and the control panel cover)	While performing a test operation of the lawnmower, press the manual STOP button. If the lawnmower does not stop (and the control panel cover does not open), consult your dealer.

1

Press the ① (On) button on the control panel.

2

Test a start point (☞ page 53).
When the lawnmower is moving, press the manual STOP button and check that the lawnmower stops.

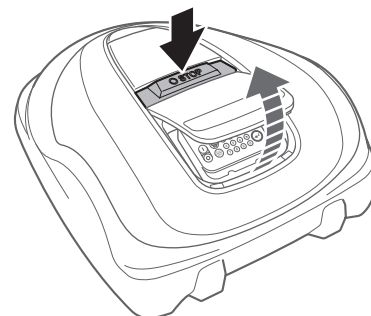

● Checking the docking station

Check item(s)		Action
Docking station	Damage to the docking station	Visually inspect the docking station. If it is damaged, consult your dealer.

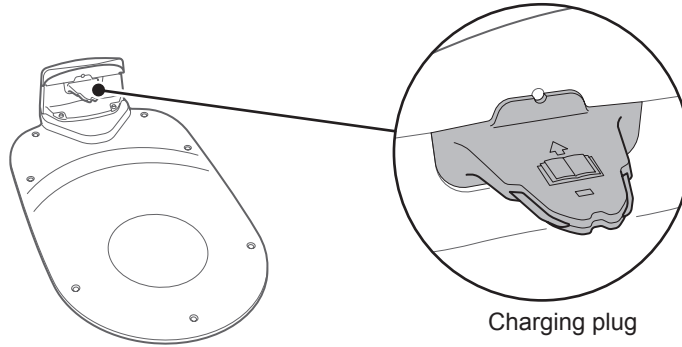

Charging plug

Check item(s)		Action
Docking station	Gap between the docking station's charging plug and the lawnmower's charging socket	Check if there is a gap between the docking station's charging plug and the lawnmower's charging socket. If there is none, adjust the docking station according to the installation conditions (▣ page 12), or consult your dealer.

1

Locate both rear wheels of the lawnmower at the highest position of the docking station.

2

Check if there is a gap between the docking station's charging plug and the lawnmower's charging socket. If there is none, adjust the docking station according to the installation conditions (▣ page 12), or consult your dealer.

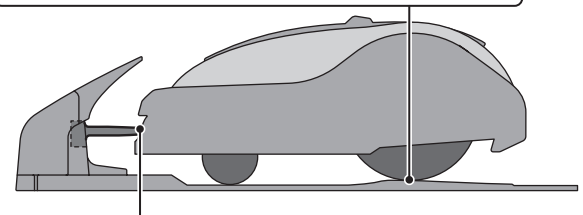
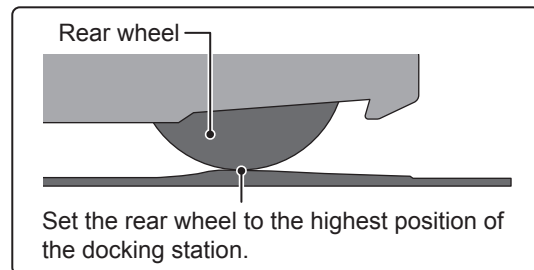

Correct

Incorrect

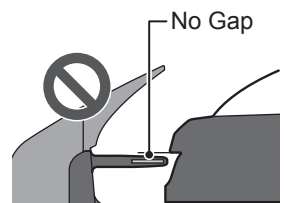
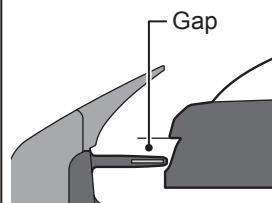

● Checking the docking station screws

Check item(s)		Action
Docking station	Loosened screws of the docking station	Visually inspect the screws. If they are loose, tighten them with a flat-blade screwdriver.

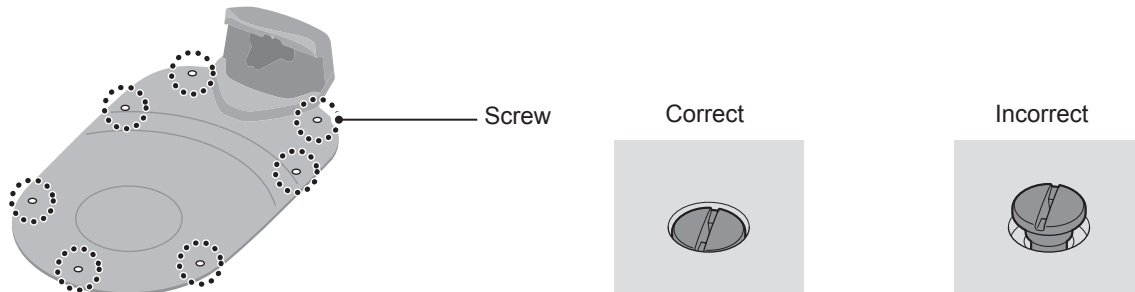

● Checking the boundary wire connectors and 4 pins connector

Check item(s)		Action
Boundary wire connectors and 4 pins connector	Looseness of the boundary wire connectors and 4 pins connector	Visually inspect the boundary wire connectors and 4 pins connector. If they are loose, insert them all the way in. If the LED indicator is red, unplug the AC adapter's plug from the power outlet (House), replug it, and then confirm that the LED indicator is back to green.

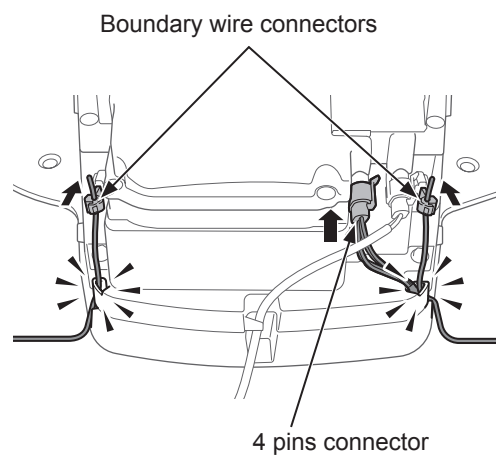

● Checking the rear (drive) tire tread depth

Check item(s)		Action
Rear (drive) tire	Tread depth of the rear (drive) tire	Measure the depth of the treads at the center of the tire. If they are 3 mm or less, contact a service dealer.

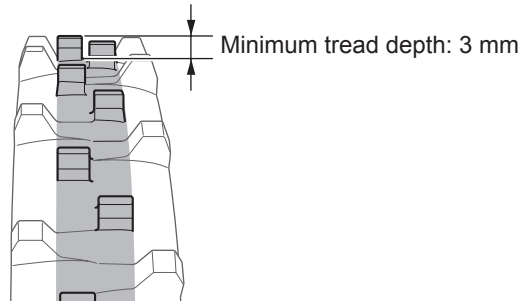

● Checking the front (caster) wheel and bearings

Check item(s)		Action
front (caster) wheel	Front (caster) wheel damage	Visually inspect the front (caster) wheel. If it is damaged, contact a service dealer.
wheel bearings	Bearing movement	Move the front (caster) wheel with your hands and check if it moves smoothly. If it does not move smoothly, contact a service dealer.

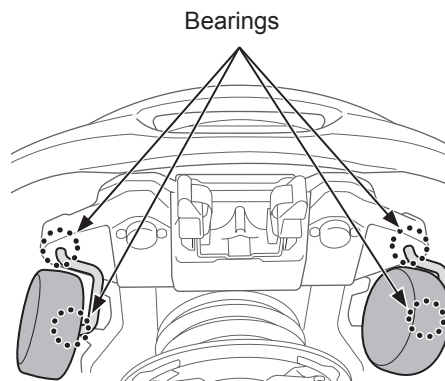

● Checking the charge socket

Check item(s)		Action
Charge socket	Charge socket clogged with grass clippings.	Visually inspect the metal parts of the charge socket. If the charge socket is clogged with grass, remove the grass clippings.

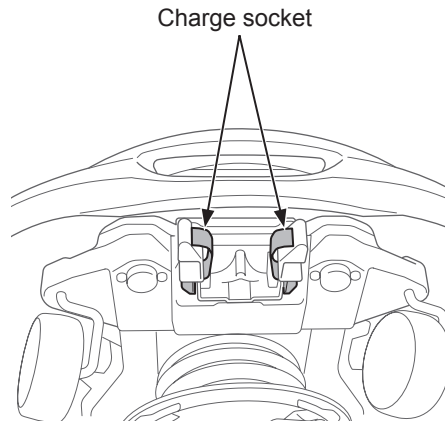

● Checking the motor housing boots

Check item(s)		Action
Motor housing boots	Motor housing boots damage or tearing	Visually inspect the motor housing boots and the boots bands. If there is damage or tearing, contact a service dealer.

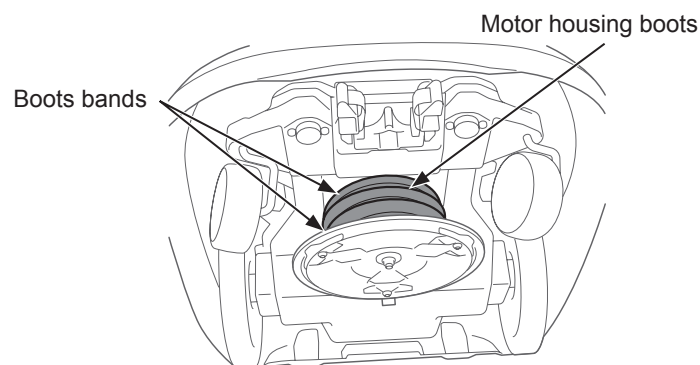

● Checking the blades and blade disc

Check the condition of the blades and blade disc as follows.

Life time of the blades

In order to have good cutting performance, maintain the sharp cutting edge on the blades. Typically, the life time of the blades is 160 hours.(2 weeks to 2 months) Because the life time depends on grass condition, it may be necessary to exchange earlier than usual, especially in the spring season.

If your lawn will become the condition of white fiber it is a sign to change blades.

Example: if the lawnmower works for 11.4 hours per day every day, the life time of the blades is 2 weeks.

If the lawnmower works for 2.6 hours per day every day, the life time of the blades is 2 months.

▲ WARNING

- Do not touch the blades with your bare hands. Put on a pair of work gloves.
- Make sure to press the manual STOP button and press the Ⓞ (Off) button to turn the power off before performing the following procedures.

NOTE:

- Hold the lawnmower against a wall for support.
- Do not lift the lawnmower off of the ground while checking it.

Check the blades, nuts and blade disc for problems.

Check item(s)		Action
Blades and nuts	Damage to the blades	Visually inspect the blades. If they are damaged, replace the blades. See "Replacing the blades" (☞ page 87).
	Loosened bases of the blades	Rotate the nuts with your finger to check that they are not loose. If the nuts are loose, tighten them to the specified torque value. See "Replacing the blades" (☞ page 87).
	Abrasions of the holes of blades and abrasions of the shoulders of nuts	Visually inspect the abrasions of the hole of blades and the abrasions of the shoulder of nuts. While mowing, the hole of the blades will widen and the shoulder of the nuts will decrease in size because of abrasions, and there is a danger that the blades will be detached from the blade disc. If they are worn, replace the blades and nuts. See "Replacing the blades" (☞ page 87).
Blade disc	Warping of the blade disc	Rotate the blade disc and visually check it. If it is warped, consult your dealer.

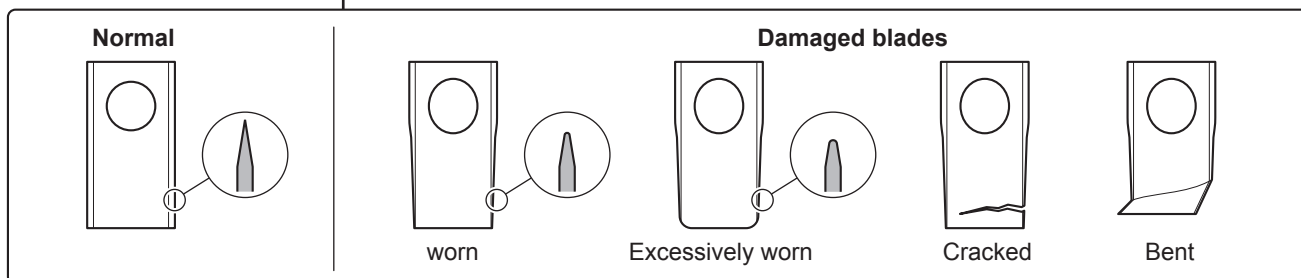
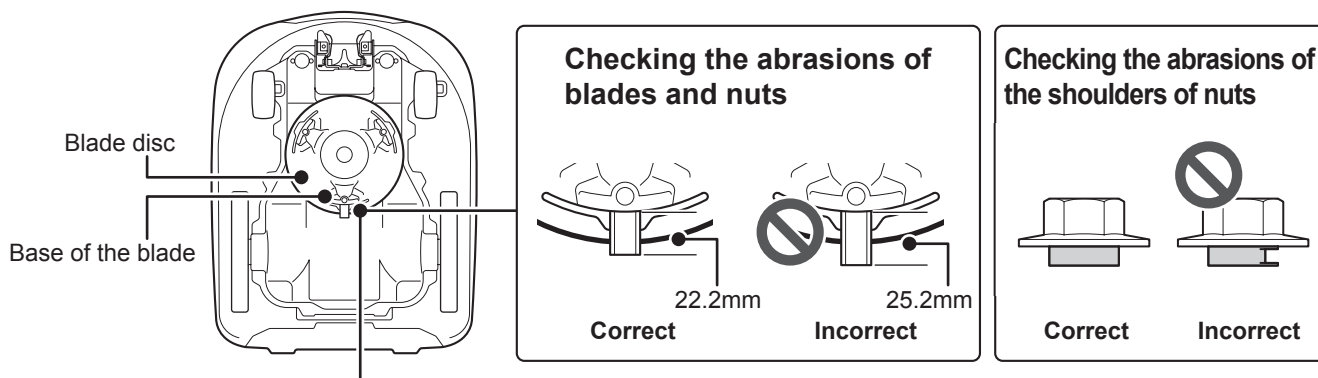

Replacing the blades

To replace the blades, perform the procedures below.

▲ WARNING

- Put on a pair of work gloves before performing the following procedures.
- Do not touch the blade while it is spinning. You may be injured if you do so.

NOTE:

- This work requires technical skill and knowledge, as well as special tools. Consult your dealer if you cannot perform the procedures below.
- Before replacing the blades, remove the grass clippings (☞ page 80).
- Use genuine parts or their equivalent for the blade.

Replacement Item(s)	Part number
Blade	72511-VP7-030
Nut	90305-VP7-000

1 After setting the cutting height to 20mm (☞ page 70), turn the power off and then turn the lawnmower upside down.

2 Hold the base of the blade disc with a 24 mm spanner so that the blade disc does not rotate when you rotate the nuts.

3 Remove the nut from each blade with a 8 mm spanner.

4 Replace the blades, insert each blade through each bolt on the blade disc, and lightly tighten a nut with the 8 mm spanner.

NOTE:

- Tighten the nuts after the shoulders of the nut is securely in the hole of the blade.

5 Tighten the nuts to the specified torque value using a torque wrench.

4.4~6.0 N • m (0.45~0.60 kgf • m, 3.2~4.4 lbf • ft)

NOTE:

- If you do not have a torque wrench, have your dealer perform the work.
- Use a torque wrench between the blade disc and the lawnmower body.

6 Check that the blades rotate smoothly. If they do not rotate smoothly, remove and install the nuts again.

Hold the blade disc in place
Insert a spanner between the blade disc holder and the lawnmower body.

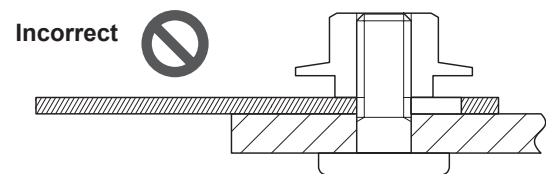
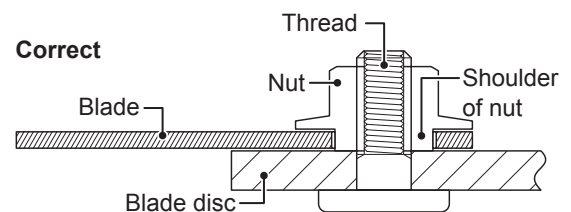
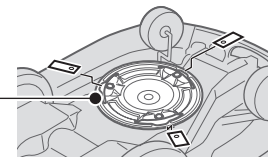

9 STORAGE

■ Winter Storage

■ Lawnmower and Docking station

It is very important that your lawnmower and docking station is cleaned thoroughly before placing into storage. The battery should be charged before it is stored in a dry place away from frost and protected from the winter weather.

Recommended battery charge level for long storage	50 - 70%
---	----------

■ Electrical Components

It is strongly recommended that you disconnect the AC adapter and power cables over winter leaving only the boundary wire in the ground. Spray electrical contact cleaner on boundary wire terminals before encasing them in a waterproof box (e.g. electrical junction box) to ensure they do not corrode over the winter period. Honda recommends that all electrical components such as the AC adapter should be stored in a dry, frost free environment that is not exposed to the winter weather.

■ Get your lawnmower ready for the new season

Before the winter season has passed and it is time to recommence your lawnmower operation it is strongly recommended that you consult your dealer. An authorised dealer will check that all systems are functioning correctly and that your lawnmower is safe to begin mowing for the forthcoming season.

10 TECHNICAL INFORMATION

Specifications

Model	HRM3000		
Description code	MBFF		
Type	E	B	S
Length	710 mm		
Width	550 mm		
Height	301 mm		
Weight	13.8 kg		
Electrical system			
Battery	Li-ion 22.2 V / 5400 mAh		
AC adapter	Input	AC 230 V	AC 240 V
	Output	DC \equiv 29.5 V / 4.3 A	
Extension cord	ICC 2X1.5 mm ² , conform with H07RN-F		
Mowing			
Blade motor speed	2290 rpm (Normal mode) / 1950 rpm (Quiet mode)		
Cutting height	20-60 mm		
Cutting width	25 cm		
Boundary wire			
Boundary wire length	750 m		
Maximum possible length	1000 m		
Frequency band(s)	2.5kHz - 5kHz		
Maximum radio-frequency power	< 82 dB μ A/m @10m		
Noise			
Sound pressure level at operator's ears EN50636-2-107:2015	Measured level 48 dB(A) Measuring uncertainty +1 dB(A) (Not exceeding 70 dB(A))		
Sound power level EN50636-2-107:2015	Measured level 58 dB(A) Measuring uncertainty +1 dB(A)		
Communication			
Bluetooth® class	2 (10 mW)		
Bluetooth® version	4.0		
Frequency band(s)	2402MHz - 2480MHz		
Maximum radio-frequency power	< 20 mW		
Garden size			
Maximum area	4000m ²		
Recommended area	3000m ²		

11 APPENDIX



Operating the lawnmower with the Manual mode

Use Manual mode when you want to ignore work timer settings.

As an example, you can move the lawnmower yourself if there is a narrow passage less than 1 m in the boundary wire range and the lawnmower cannot pass through.

● Example of manual mode operation

These instructions can be used to operate the lawnmower for the Manual mode settings.

- 1 See "Manual Mode" (☞ page 45) to configure settings for Manual Mode.
- 2 Press the  (Off) button on the control panel.
The power turns off.
- 3 Close the control panel cover.
- 4 Carry the lawnmower to the desired area.
For details on carrying the lawnmower, see "8 MAINTENANCE" (☞ page 79).
Instead of carrying the lawnmower, you can drive it with Mii-monitor application Remote Controller.
- 5 Press the manual STOP button.
The control panel cover pops up.
- 6 Press the  (On) button on the control panel.
The power turns on, and the startup screen on the control panel is displayed.
- 7 Enter the PIN using the number buttons to display the Home screen.
- 8 Press the  (Auto / Manual) button repeatedly until Manual mode screen is displayed.

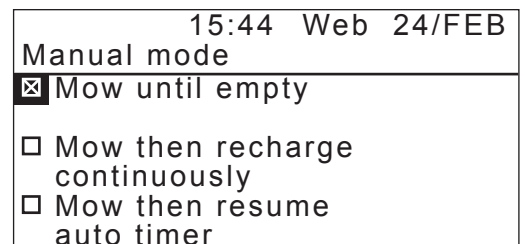

9

Select an operation of lawnmower.

Items	Description
Mow until empty	The lawnmower works until battery is empty.
Mow then recharge continuously	The lawnmower works and charges until the work mode is changed to Auto mode by the user.
Mow then resume auto timer	You can specify how many times the lawnmower works and charges (1 – 10 times). After the specified number of times, the lawnmower switches to Auto mode and resumes the timer.

10

Press the  button.

11

Close the control panel cover.

The lawnmower automatically begins to operate.

NOTE:

- The lawnmower does not turn off automatically when in manual mode.

● Canceling the Manual mode operation

You can cancel the operation which you selected on the Manual mode screen and the lawnmower returns to the docking station.

1

Press the manual STOP button from behind the lawnmower.

NOTE:

- If you select [Mow then resume auto timer] the lawnmower will stop at the time of the work timer configured in the Auto mode.

2

Press the  (Off) button on the control panel.

The power turns off.

3

Place the lawnmower in a area that is near the docking station.

4

Press the  (On) button on the control panel.

The power turns on, and the startup screen on the control panel is displayed.

5

Enter the PIN using the number buttons to display the Home screen.

6

Press the  (Home) button.

7 Select the operation of lawnmower after going back to the docking station.

15:45 Web 24/FEB
Go back Home
Then after charging:
<input checked="" type="checkbox"/> Restart on next timer
<input type="checkbox"/> Pause mowing at home for the specified time
<input type="checkbox"/> Stay at Home

Items	Description
Restart on next timer	The lawnmower goes back home, then switches automatically to Auto mode and resumes the timer.
Pause mowing at home for the specified time.	You can set the standby time of the lawnmower to 1 – 24 hours. After the standby time has passed, the lawnmower switches to Auto mode.
Stay at home	The lawnmower stays at the docking station after charging.

8 Press the  button.
Home screen is displayed.

9 Close the control panel cover.
The lawnmower returns to the docking station.

Major Honda Distributor Addresses

AUSTRIA

Honda Motor Europe Ltd
Hondasträße 1
2351 Wiener Neudorf
Tel.: +43 (0)2236 690 0
Fax: +43 (0)2236 690 480
<http://www.honda.at>
✉ HondaPP@honda.co.at

BALTIC STATES

(Estonia/Latvia/Lithuania)
NGC Import Baltics OÜ
Meistri 12
Haabersti District
13517 Tallinn
Harju County Estonia
Tel.: +372 651 7300
Fax: +372 651 7301
✉ info.baltic@ngcimport.com

BELARUS

UAB JP Motors
Montazhnikov lane 4th, 5-16
Minsk 220019
Republic of Belarus
Tel.: +375172349999
Fax: +375172380404
✉ Dudarevich@scanlink.by

BELGIUM

Honda Motor Europe Ltd
Doornveld 180-184
1731 Zellik
Tel.: +32 2620 10 00
Fax: +32 2620 10 01
<http://www.honda.be>
✉ BH_PE@HONDA-EU.COM

BULGARIA

Premium Motor Ltd
Andrey Lyapchev Blvd no 34
1797 Sofia
Bulgaria
Tel.: +3592 423 5879
Fax: +3592 423 5879
<http://www.hondamotor.bg>
✉ office@hondamotor.bg

CROATIA

Hongoldonia d.o.o.
Vukovarska ulica 432a
31000 Osijek, HR
Tel.: +38531320420
Fax: +38531320429
<http://www.hongoldonia.hr>
✉ prodaja@hongoldonia.hr

CROATIA

Fred Bobek d.o.o.
HONDA MARINE
Put Gačelega 5b
HR 22211 Vodice
Tel. 00385 22 444336
Fax. 00385 22 440500
✉ centrala@honda-croatia.com

CYPRUS

Demstar Automotive Ltd
Mihail Giorgallia 14
2409 Engomi
Nicosia
Cyprus
Tel.: +357 22 792 600
Fax: +357 22 430 313

CZECH REPUBLIC

BG Technik cs, a.s.
U Zavodiste 251/8
15900 Prague 5 - Velka
Chuchle
Tel.: +420 2 838 70 850
Fax: +420 2 667 111 45
<http://www.honda-stroje.cz>

DENMARK

TIMA A/S
Ryttermarken 10
DK-3520 Farum
Tel.: +45 36 34 25 50
Fax: +45 36 77 16 30
<http://www.tima.dk>

FINLAND

OY Brandt AB.
Tuupakantie 7B
01740 Vantaa
Tel.: +358 207757200
Fax: +358 9 878 5276
<http://www.brandt.fi>

FRANCE

Honda Motor Europe Ltd
Division Produit d'Equipement
Parc d'activités de Pariest,
Allée du 1er mai
Croissy Beaubourg BP46, 77312
Marne La Vallée Cedex 2
Tel.: 01 60 37 30 00
Fax: 01 60 37 30 86
<http://www.honda.fr>
✉ espace-client@honda-eu.com

GERMANY

Honda Deutschland
Niederlassung der Honda Motor
Europe Ltd.
Hanauer Landstraße 222-224
D-60314 Frankfurt
Tel.: 01805 20 20 90
Fax: +49 (0)69 83 20 20
<http://www.honda.de>
✉ info@post.honda.de

GREECE

Saracakis Brothers S.A.
71 Leoforos Athinon
10173 Athens
Tel.: +30 210 3497809
Fax: +30 210 3467329
<http://www.honda.gr>
✉ info@saracakis.gr

HUNGARY

MP Motor Co., Ltd.
Kamaraerdei ut 3.
2040 Budaors
Tel.: +36 23 444 971
Fax: +36 23 444 972
<http://www.hondakisgepek.hu>
✉ info@hondakisgepek.hu

IRELAND

Two Wheels Ltd
M50 Business Park, Ballymount
Dublin 12
Tel.: +353 1 4381900
Fax: +353 1 4607851
<http://www.hondaireland.ie>
✉ sales@hondaireland.ie

ISRAEL

Mayer's Cars and Trucks Co.Ltd. -
Honda Division
Shevach 5, Tel Aviv , 6777936
Israel
+972-3-6953162
✉ OrenBe@mct.co.il

ITALY

Honda Motore Europe Ltd
Via della Cecchignola, 13
00143 Roma
Tel.: +848 846 632
Fax: +39 065 4928 400
<http://www.hondaitalia.com>
✉ info.power@honda-eu.com

MACEDONIA

Makpetrol A.D. Honda Centar
Bul.sv Kiril i Metodij br. 4
1000, Skopje
Republic of Macedonia
✉ aleksandar.stanojlovic@makpetrol.com.mk

MALTA

The Associated Motors
Company Ltd.
New Street in San Gwakklin Road
Mriehel Bypass, Mriehel QRM17
Tel.: +356 21 498 561
Fax: +356 21 480 150
✉ mgalea@gasanzammit.com

NORWAY

Berema AS
P.O. Box 454 1401 Ski
Tel.: +47 64 86 05 00
Fax: +47 64 86 05 49
<http://www.berema.no>
✉ berema@berema.no

NORWAY

KELLOX
Box 24, N-141
Trollåsveien 36, 1414
Trollåsen, Norway
Mobile: +47 47 80 90 00
Phone: +47 64 97 61 00
<http://kellox.no/>
✉ finn.hoge@kellox.no

POLAND

Aries Power Equipment
Puławska 467
02-844 Warszawa
Tel.: +48 (22) 861 43 01
Fax: +48 (22) 861 43 02
<http://www.ariespower.pl>
<http://www.mojahonda.pl>
✉ info@ariespower.pl

PORTUGAL

GROW Productos de Forza
Portugal
Rua Fontes Pereira de Melo, 16
Abrunheira, 2714-506 Sintra
Tel.: +351 211 303 000
Fax: +351 211 303 003
<http://www.grow.com.pt>
✉ geral@grow.com.pt

ROMANIA

Hit Power Motor Srl
7-15 Argonomoni Bulevard
Building N3.2
Entrance A
Apt 8, Floor 2
Sector 1
015141 Bucharest
Tel.: +40 21 637 04 58
Fax: +40 21 637 04 78
<http://www.honda.ro/>
<http://honda-eu.ro>
✉ office@honda.ro

ROMANIA

Agrisorg
Sacadat 444/A
Bihor
Romania
417430
<http://www.agrisorg.com>
✉ adrian@agrisorg.com

SERBIA & MONTENEGRO

ITH Trading Co Doo
Majke Jevrosime 26
1100 Beograd
Serbia
Tel.: +381 11 3240627
Fax: +381 11 3240627
<http://www.hondasrbija.co.rs>
✉ sstevanovic@ithtrading.co.rs

SLOVAK REPUBLIC

Honda Motor Europe Ltd
Slovensko, organizačná zložka
Prievozská 6 821 09 Bratislava
Tel.: +421 2 32131111
Fax: +421 2 32131112
<http://www.honda.sk>

SLOVENIA

AS Domzale Moto Center D.O.O.
Blatnica 3A
1236 Trzin
Tel.: +386 1 562 3700
Fax: +386 1 562 3705
<http://www.honda-as.com>
✉ infomacije@honda-as.com

SPAIN & all Provinces

Greens Power Products, S.L.
Poligono Industrial Congost –
Av Ramon Cuirans n°2
08530 La Garriga - Barcelona
Tel.: +34 93 860 50 25
Fax: +34 93 871 81 80
<http://www.hondaencasa.com>

SWEDEN

Honda Motor Europe Ltd filial
Sverige
Box 31002 - Långhusgatan 4
215 86 Malmö
Tel.: +46 (0)40 600 23 00
Fax: +46 (0)40 600 23 19
<http://www.honda.se>
✉ hpesinfo@honda-eu.com

SWITZERLAND

Honda Motor Europe Ltd., Slough
Succursale de Satigny/Genève
Rue de la Bergère 5
1242 Satigny
Tel.: +41 (0)22 989 05 00
Fax: +41 (0)22 989 06 60
<http://www.honda.ch>

TURKEY

Anadolu Motor Uretim Ve
Pazarlama As
Sekerpinar Mah
Albayrak Sok No 4
Cayirova 41420
Kocaeli
Tel.: +90 262 999 23 00
Fax: +90 262 658 94 17
<http://www.anadolumotor.com.tr>
✉ antor@antor.com.tr

UKRAINE

Dnipro Motor LLC
3, Bondarsky Alley,
Kyiv, 04073, Ukraine
Tel.: +380 44 537 25 76
Fax: +380 44 501 54 27
✉ igor.ljubunets@honda.ua

UNITED KINGDOM

Honda Motor Europe Ltd
Cain Road
Bracknell
Berkshire
RG12 1 HL
Tel.: +44 (0)845 200 8000
<http://www.honda.co.uk>

“EC Declaration of Conformity” CONTENT OUTLINE

EC Declaration of Conformity

- The undersigned, *2, representing the manufacturer, herewith declares that the machinery described below fulfils all the relevant provisions of:
 - Directive 2006/42/EC on machinery
 - Directive 2014/30/EU on electromagnetic compatibility
 - Directive 2014/35/EU relating to electrical equipment designed for use within certain voltage limits
 - Directive 2014/53/EU on radio equipment
 - Directive 2011/65/EU on the restriction of the use of certain hazardous substances in electrical and electronic equipment

2. Description of the machinery

- Product: Robotic lawnmower
- Function: Cutting of grass

c) Model	d) Type	e) Serial number
*1	*1	

3. Manufacturer and able to compile the technical documentation

Honda France Manufacturing S.A.S.
Pôle 45 - Rue des Châtaigniers 45140 ORMES - FRANCE

4. References to applied standards

EN 60335-1:2012/A11:2014/AC:2014
EN 50636-2-107:2015
EN 55014-1:2006/A1:2009/A2:2011
EN 55014-2:2015
EN 61000-3-2:2014
EN 61000-3-3: 2013

EN 301 489-1 V1.9.2
Draft ETSI EN 301 489-1 V2.2.0 (2017-03)
ETSI EN 301 489-17 V2.2.1 (2012-09)
Draft ETSI EN 301 489-17 V3.2.0 (2017-03)
EN 300 328 V2.1.1
ETSI EN 303 447 V1.1.1 (2017-09)

5. 2014/53/EU: Annex III (Module B, EU-type examination)

The notified body (VDE, 0366) performed EU-type examination and issued the EU-type examination certificate: *2

6. Done at:

ORMES, FRANCE

7. Date:

*2

*1 : See specification page

*2 : See original EC Declaration of Conformity

*2

President

Honda France Manufacturing S.A.S.

OBS421 SIMPLIFIED EU DECLARATION OF CONFORMITY

Hereby, u-blox AG declares that the radio equipment type OBS421 is in compliance with Directive 2014/53/UE. The full text of the EU declaration of conformity is available at the following internet address:

[https://www.u-blox.com/en/product-resources?f\[0\]=field_file_category%3A220](https://www.u-blox.com/en/product-resources?f[0]=field_file_category%3A220)

<p>French (French) Déclaration CE de Conformité 1. Le soussigné, *2, représentant du constructeur, déclare que la machine décrite ci-dessous répond à toutes les dispositions applicables de * Directive Machine 2006/42/CE * Directive 2014/30/UE en lien avec la compatibilité électromagnétique * Directive 2014/35/UE relatives au matériel électrique destiné à être employé dans certaines limites de tension * Directive 2014/53/UE concernant les équipements hertziens * Directive 2011/65/UE relative à la limitation de l'utilisation de certaines substances dangereuses dans les équipements électriques et électroniques 2. Description de la machine a) Produit: Tondeuse à gazon robotisée b) Fonction : couper de l'herbe (tondeuse) c) Modèle d) Type e) Numéro de série 3. Constructeur et en charge des éditions de documentation techniques 4. Référence aux normes appliquées 5. 2014/53/UE : ANNEXE III (Module B, Examen UE de type) l'organisme notifié (VDE, 0366) a réalisé l'examen UE de type et délivré le certificat d'examen UE de type. 6. Fait à 7. Date OBS421 DECLARATION UE DE CONFORMITÉ SIMPLIFIÉE Le soussigné, u-blox AG, déclare que l'équipement radioélectrique du type OBS421 est conforme à la directive 2014/53/UE. Le texte complet de la déclaration UE de conformité est disponible à l'adresse internet suivante:</p>	<p>Italiano (Italian) Dichiarazione CE di Conformità 1. Il sottoscritto, *2 in rappresentanza del costruttore, dichiara qui di seguito che la macchina sotto descritta soddisfa tutte le disposizioni pertinenti delle: * Direttiva macchine 2006/42/CE * Direttiva 2014/30/UE sulla compatibilità elettromagnetica * Direttiva 2014/35/UE relative al materiale elettrico destinato ad essere adoperato entro taluni limiti di tensione * Direttiva 2014/53/UE riguardante le apparecchiature radio * Direttiva 2011/65/UE sulla restrizione dell'uso di determinate sostanze pericolose nelle apparecchiature elettriche ed elettroniche 2. Descrizione della macchina a) Prodotto: Rasaerba robotizzato b) Funzione : Taglio di erba c) Modello d) Tipo e) Numero di serie 3. Costruttore e competente per la compilazione della documentazione tecnica 4. Riferimento alle norme applicate 5. 2014/53/UE: ALLEGATO III (Modulo B, Esame UE del tipo) l'organismo notificato (VDE, 0366) ha effettuato l'esame UE del tipo e rilasciato il certificato di esame UE del tipo. 6. Fatto a 7. Data OBS421 DICHIARAZIONE DI CONFORMITÀ UE SEMPLIFICATA Il fabbricante, u-blox AG, dichiara che il tipo di apparecchiatura radio OBS421 è conforme alla direttiva 2014/53/UE. Il testo completo della dichiarazione di conformità UE è disponibile al seguente indirizzo Internet:</p>	<p>Deutsch (German) EU-Konformitätserklärung 1. Der Unterzeichner, *2 der den Hersteller vertritt, erklärt hiermit dass das hierunter genannte Maschine allen einschlägigen Bestimmungen der * entspricht. * Maschinenrichtlinie 2006/42/EG * Richtlinie 2014/30/EU über die elektromagnetische Verträglichkeit * Richtlinie 2014/35/EU betreffend elektrische Betriebsmittel zur Verwendung innerhalb bestimmter Spannungsgrenzen * Richtlinie 2014/53/EU über Funkanlagen * Richtlinie 2011/65/EU zur Beschränkung der Verwendung bestimmter gefährlicher Stoffe in Elektro- und Elektronikgeräten 2. Beschreibung der Maschine a) Produkt: Rasenmäher Roboter b) Funktion : Gras schneiden c) Modell d) Typ e) Seriennummer 3. Hersteller und in der Position, die technische Dokumentation zu erstellen 4. Verweis auf anwendbare Standards 5. 2014/53/UE: ANHANG III (Modul B, EU-Baumusterprüfung) Die notifizierte Stelle (VDE, 0366) hat EU-Baumusterprüfung und folgende EU-Baumusterprüfbescheinigung ausgestellt: 6. Ort 7. Datum OBS421 VEREINFACHTE EU-KONFORMITÄTserklärung Hiermit erklärt u-blox AG, dass der Funkanlagentyp OBS421 der Richtlinie 2014/53/UE entspricht. Der vollständige Text der EU-Konformitätserklärung ist unter der folgenden Internetadresse verfügbar:</p>	<p>Nederlands (Dutch) EG-verklaring van overeenstemming 1. Ondergetekende, *2, vertegenwoordiger van de constructeur, verklaart hiermee dat het hieronder beschreven machine voldoet aan alle toepasselijke bepalingen van: * Richtlijn 2006/42/EG betreffende elektrische machines * Richtlijn 2014/30/EE inzake elektrische compatibiliteit * Richtlijn 2014/35/UE betreffende elektrische materiaal bestemd voor gebruik binnen bepaalde spanningsgrenzen * Richtlijn 2014/53/UE betreffende radioapparatuur * Richtlijn 2011/65/UE betreffende beperking van het gebruik van bepaalde gevaarlijke stoffen in elektrische en elektronische apparatuur 2. Beschrijving van de machine a) Product: Robotmaaier b) Functie : gras maaien c) Model d) Type e) Serienummer 3. Fabrikant en in staat om de technische documentatie samen te stellen 4. Referentie voor toegepaste normen 5. 2014/53/UE: BIJLAGE III (Module B, EU-typeonderzoek) De aangemelde instantie (VDE, 0366) heeft een EU-typeonderzoek uitgevoerd en het certificaat van EU-typeonderzoek afgegeven: 6. Plaats 7. Datum OBS421 VEREENVOUDIGDE EU-KONFORMITEITSVERKLARING Hierbij verklaar ik, u-blox AG, dat het type radioapparaat OBS421 conform is met Richtlijn 2014/53/UE. De volledige tekst van de EU-conformiteitsverklaring kan worden geraadpleegd op het volgende internetadres:</p>
<p>Dansk (Danish) EF OVERENSSTÆMMESEERKLÆRING 1. UNDERTEGNEDE, *2, SOM REPRÆSENTERER PRODUCENTEN, ERKLÆRER HERMED AT MASKINEN, SOM ER BESKREVET NEDENFOR, OPFYLDER ALLE RELEVANTE BESTEMMELSER I FØLGENDE: * MASKINDIREKTIV 2006/42/EF * Direktiv 2014/30/EU om elektromagnetisk kompatibilitet * Direktiv 2014/35/UE om elektrisk materiel bestemt til anvendelse inden for visse spændingsgrænser * Direktiv 2014/53/UE om radioudrustning * direktiv 2011/65/UE om begrænsning af anvendelsen af visse farlige stoffer i elektrisk og elektronisk udstyr 2. BESKRIVELSE AF PRODUKTET a) Produkt: Robotklipper b) ANVENDELSE : Græsklipping c) Model d) TYPE e) SERIENUMMER 3. PRODUKT OG I STAND TIL AT UDARBEJDE DEN TEKNISKE DOKUMENTATION 4. Henvisning til anvendte standarder 5. 2014/53/UE: BILAG III (Modul B, EU-typeafprøvning) det bemyndigede organ (VDE, 0366) har foretaget EU-typeafprøvning og udstedt EU-typeafprøvningsattest: 6. STED 7. DATO OBS 421 FORENKLETT EU- OVERENSSTÆMMESEERKLÆRING Hermed erklærer u-blox AG, at radioudrustningen OBS421 er i overensstemmelse med direktiv 2014/53/UE. EU-overensstemmelse erklæringens fulde tekst kan findes på følgende internetadresse:</p>	<p>Ελληνικά (Greek) ΕΚ-Δήλωση συμμόρφωσης 1. Ο κ. υπογράφων, *2, εκπροσωπώντας τον κατασκευαστή, δηλώνει ότι το παρακάτω περιγραφόμενο όχημα πληροί όλες τις σχετικές προδιαγραφές του: * Οδηγία 2006/42/ΕΚ για μηχανές * Οδηγία 2014/30/ΕΕ σχετικά με την ηλεκτρομαγνητική συμβατότητα * Οδηγία 2014/35/ΕΕ αναφορικά με τον ηλεκτρολογικό υλικό που προορίζεται να χρησιμοποιηθεί εντός ορισμένων ορίων τάσης * Οδηγία 2014/53/ΕΕ σχετικά με το ραδιοεξοπλισμό * Οδηγία 2011/65/ΕΕ για τον περιορισμό της χρήσης ορισμένων επικίνδυνων ουσιών σε ηλεκτρικό και ηλεκτρονικό εξοπλισμό 2. Περιγραφή μηχανήματος a) προϊόν: Αυτόματο γλυσκοκίτη b) Λειτουργία : για κόψιμο γρασίδιού c) Μοντέλο d) Τύπος e) Αριθμός σειράς παραγωγής 3. Κατασκευαστής και να είναι σε θέση να καταρτίσει τον τεχνικό φάκελο 4. Παραπομπή στα ισχύοντα πρότυπα 5. 2014/53/ΕΕ: ΠΑΡΑΡΤΗΜΑ ΙΙΙ (Ενότητα Β, Εξέταση τύπου ΕΕ) ο κοινοποιημένος οργανισμός (VDE, 0366) πραγματοποίησε Εξέταση τύπου ΕΕ και εξέδωσε το πιστοποιητικό εξέτασης τύπου ΕΕ: 6. Η δοκιμή έγινε 7. Ημερομηνία OBS421 ΑΠΛΟΥΣΤΕΥΜΕΝΗ ΑΗΘΩΣΗ ΣΥΜΜΟΡΦΩΣΗΣ ΕΕ Με την παρούσα οίη u-blox AG, δηλώνει ότι ο ραδιοεξοπλισμός OBS421 πληροί την οδηγία 2014/53/ΕΕ. Το πλήρες κείμενο της δήλωσης συμμόρφωσης ΕΕ διατίθεται στην ακόλουθη ιστοσελίδα στο διαδίκτυο:</p>	<p>Svenska (Swedish) EG-försäkran om överensstämmelse 1. Undertecknad, *2, representant för tillverkaren, deklarerar härmed att maskinen beskriven nedan fullföljer alla relevanta bestämmelser av: * Direktiv 2006/42/EG gällande maskiner * Direktiv 2014/30/EU på elektromagnetisk kompatibilitet * Direktiv 2014/35/EU om elektrisk utrustning avsedd för användning inom vissa spänningsgränser * Direktiv 2014/53/UE om begränsning av användning av vissa farliga ämnen i elektrisk och elektronisk utrustning 2. Maskinbeskrivning a) Produkt: Robotgräsklippare b) Funktion : gräsklippning c) Modell d) Typ e) Serienummer 3. Tillverkare och ska kunna sammanställa teknisk dokumentation. 4. Referens för tillämplad standard 5. 2014/53/UE: BILAGA III (Modul B, EU-typkontroll) det anmälda organet (VDE, 0366) har utfört EU-typkontroll och utfärdat EU-typgodkänningsintyg: 6. Utfärdat vid 7. Datum OBS421 FÖRENKLAD EU-FÖRSÄKRAN OM ÖVERENSSTÄMMELSE Härmed försäkras u-blox AG att denna typ av radioudrustning OBS421 överensstämmer med direktiv 2014/53/UE. Den fullständiga texten till EU-försäkran om överensstämmelse finns på följande webbadress:</p>	<p>Español (Spanish) Declaración de Conformidad CE 1. El firmante, *2, en representación del fabricante, adjunto declara que la máquina abajo descrita, cumple las cláusulas relevantes de: * Directiva 2006/42/CE de maquinaria * Directiva 2014/30/UE sobre compatibilidad electromagnética * Directiva 2014/35/UE sobre el material eléctrico destinado a utilizarse con determinados límites de tensión * Directiva 2014/53/UE sobre equipos radioeléctricos * Directiva 2011/65/UE sobre restricciones a la utilización de determinadas sustancias peligrosas en aparatos eléctricos y electrónicos 2. Descripción de la máquina a) Producto: Robot cortacésped b) Función : Cortar el césped c) Modelo d) Tipo e) Número de serie 3. Fabricante que puede compilar el expediente técnico 4. Referencia a normas aplicadas 5. 2014/53/UE: ANEXO III (Módulo B, Examen UE de tipo) El organismo notificado (VDE, 0366) ha efectuado Examen UE de tipo y expedido el certificado de conformidad UE de tipo. 6. Realizado en 7. Fecha OBS421 DECLARACIÓN UE DE CONFORMIDAD SIMPLIFICADA Por la presente, u-blox AG declara que el tipo de equipo radioeléctrico OBS421 es conforme con la Directiva 2014/53/UE. El texto completo de la declaración UE de conformidad está disponible en la dirección Internet siguiente:</p>

LCD MENU INDEX

Menu name	Step	Page
A Alarm	System settings → Security	P.60
	Garden setup → Auto mode	P.38
B BG color	System settings → Display/Sound	P.58
C Capacity for homing	Garden setup → Homing setup	P.49
	Check signal	Diagnostics
	Contrast	System settings → Display/Sound
	Create a PIN	System settings → Security
	Cutting height	Garden setup
D Date and time	System settings	P.59
	Garden setup → Garden layout	P.47
E Edge cutting	Garden setup → Auto mode	P.42
	Garden setup → Manual mode	P.45
F Factory reset	System settings → Reset	P.61
	History	P.57
G Garden layout	Garden setup	P.47
H Help	Press and hold number button "0"	P.61
	Garden setup	P.48
K Keypad	System settings → Display/Sound	P.59
L Language	System settings	P.58
M Manual mode	Garden setup	P.45
	Mowing pattern	Garden setup → Auto mode
	Mowing pattern	Garden setup → Manual mode
	Mowing start points	Garden setup → Auto mode → Mowing start point
	Mowing start Points	Work timer
N Narrow passage	Garden setup → Auto mode	P.44
O Operating time	History → Operating history	P.55
	Operation history	History
P Passage width	Garden setup → Homing setup	P.48
Q Quiet timer	Work timer	P.37
R Restore dealer setup	System settings → Reset	P.61
S Seasonal timer	Work timer	P.36
	Security	System settings
	Setup wizard	Setup wizard
	Spiral cutting	Garden setup → Auto mode
	Spiral cutting	Garden setup → Manual mode
T Test start points	Diagnostics → Test start points	P.53
W Wire length	Garden setup → Garden layout	P.47
	Wire overlap	Garden setup → Auto mode
	Wire overlap	Garden setup → Manual mode
	Work history	History → Operating history
	Work timer	Work timer

LAWN DIAGRAM

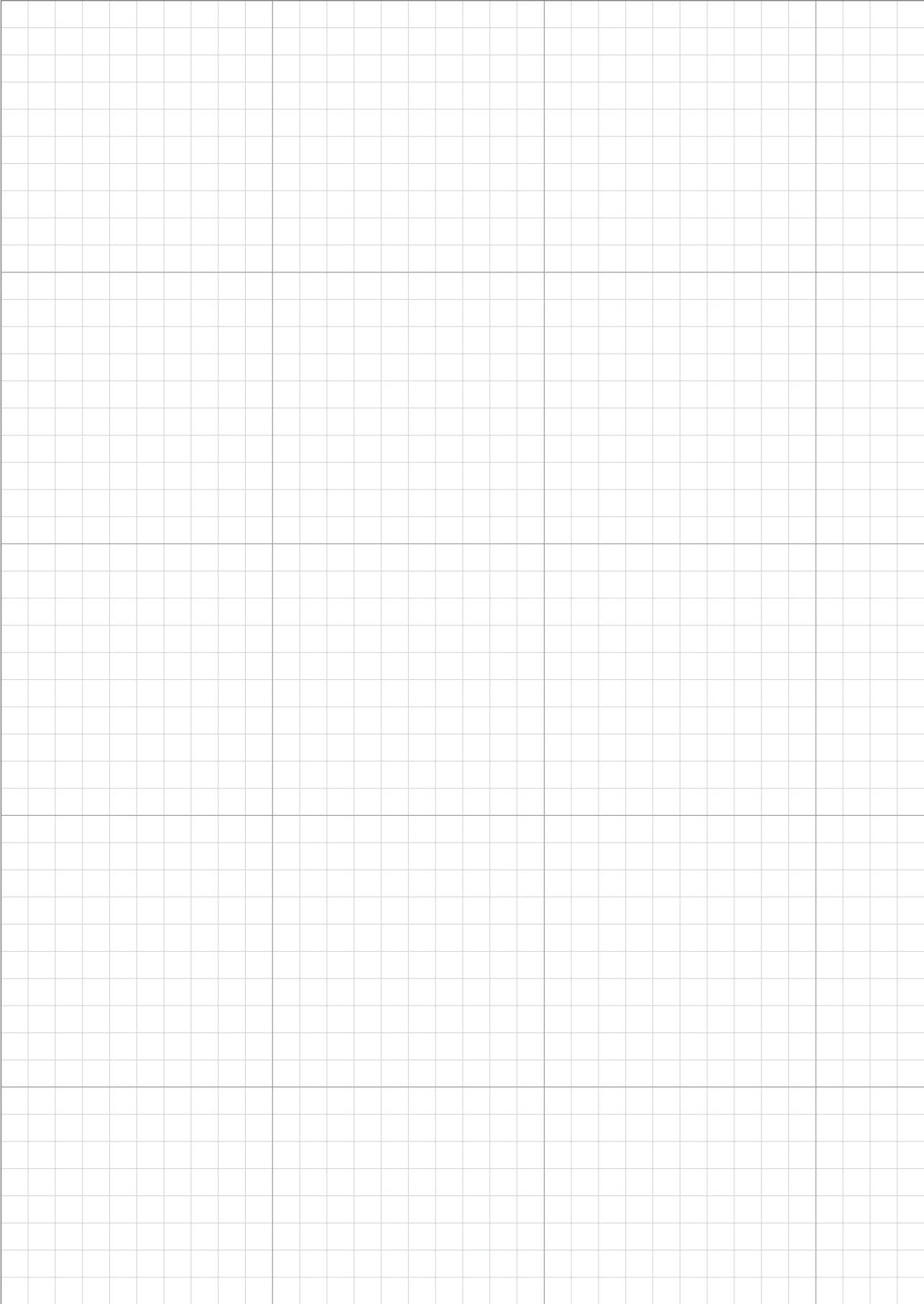

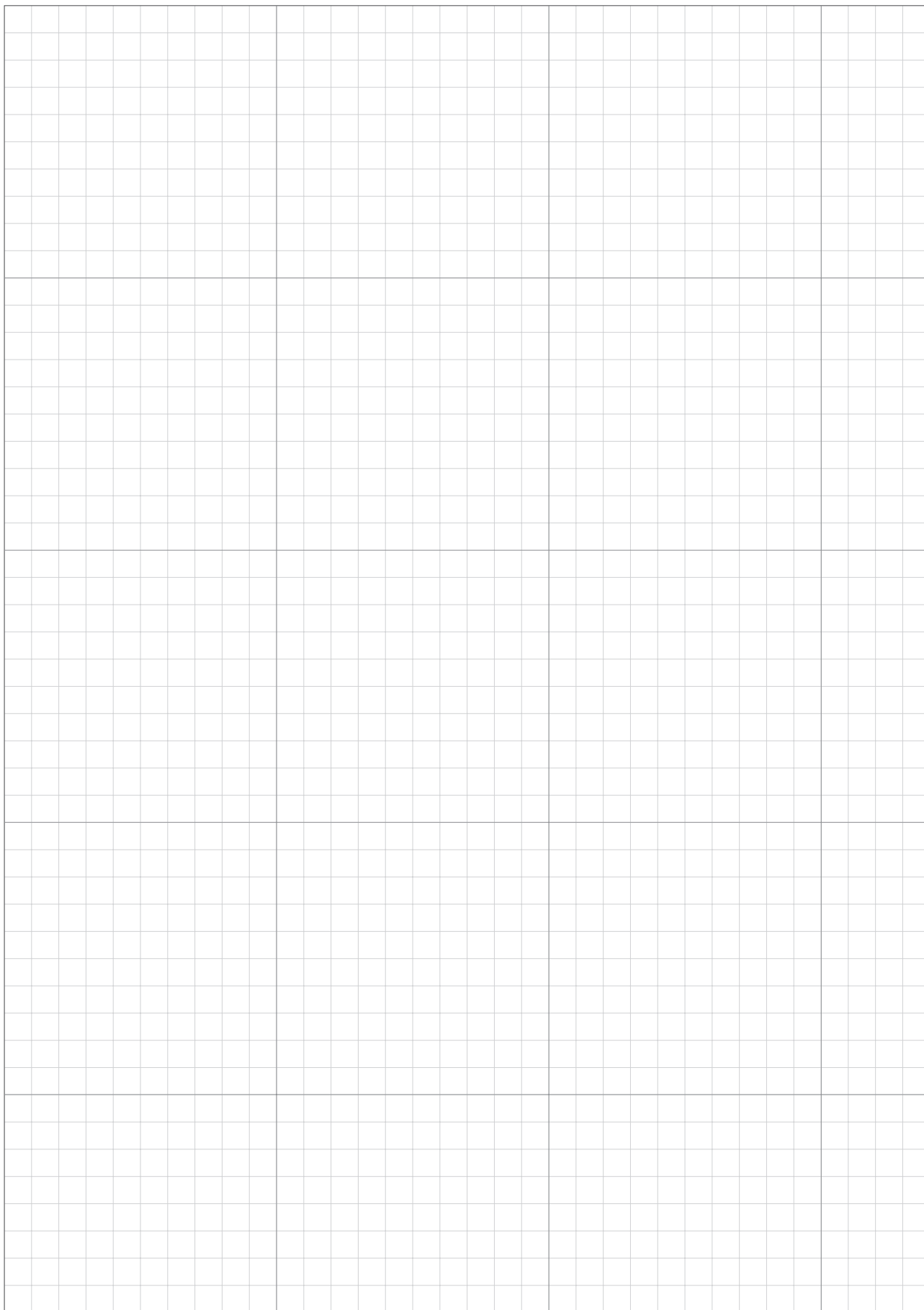

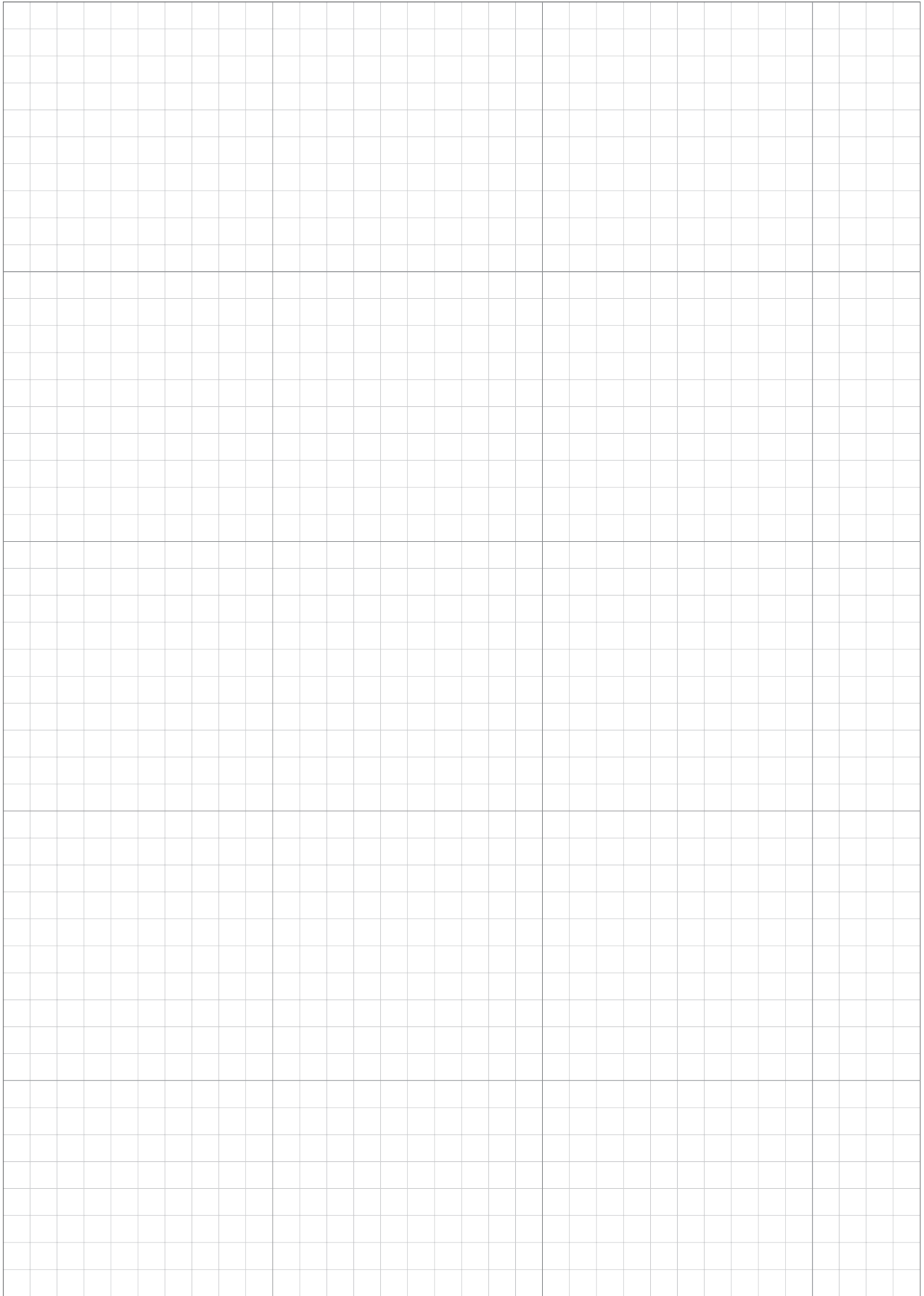

DEALER CHECKSHEET

The following information is provided by your dealer after setup is complete. You can save your settings using Mii-monitor and restore them in case you made unwanted modifications. You can also restore your dealer's recommended settings from Mii-monitor to your lawnmower.

Basic setting information (pages 18, 60)

PIN (Personal Identification Number):

--	--	--	--

Language : English / Deutsch / Français / Italiano / Nederlands / Svenska / Norsk / Español / Polski / Dansk / Suomalainen / Čeština

Setup wizard setting information (page 19)

The following items are related to the basic settings for Setup wizard.

Garden layout (page 19)

Docking direction: 1 / 2 / 3 / 4 Wire length: _____ m
 Garden size: _____ m² Narrow passage: _____ cm

Mowing start point (page 23)

Starting points	Direction	From station to start point	Area percentage
Point 1	CW / ACW	m	%
Point 2	CW / ACW	m	%
Point 3	CW / ACW	m	%
Point 4	CW / ACW	m	%
Point 5	CW / ACW	m	%

Work timer (page 26)

Day of the week	Timer 1	Timer 2	Starting point
Monday	_ : _ - _ : _	_ : _ - _ : _	1 / 2 / 3 / 4 / 5
Tuesday	_ : _ - _ : _	_ : _ - _ : _	1 / 2 / 3 / 4 / 5
Wednesday	_ : _ - _ : _	_ : _ - _ : _	1 / 2 / 3 / 4 / 5
Thursday	_ : _ - _ : _	_ : _ - _ : _	1 / 2 / 3 / 4 / 5
Friday	_ : _ - _ : _	_ : _ - _ : _	1 / 2 / 3 / 4 / 5
Saturday	_ : _ - _ : _	_ : _ - _ : _	1 / 2 / 3 / 4 / 5
Sunday	_ : _ - _ : _	_ : _ - _ : _	1 / 2 / 3 / 4 / 5

Seasonal timer:

Region: North / North Central / South Central / South

Percentage: JAN : _____ % FEB : _____ % MAR : _____ % APR : _____ %
 MAY : _____ % JUN : _____ % JUL : _____ % AUG : _____ %
 SEP : _____ % OCT : _____ % NOV : _____ % DEC : _____ %

Other setting item information

Please fill the following items if configuring them with the Menu settings.

Garden layout setting information (pages 40, 44, 47, 48)

Passage width:

 **Home screen** → [2.Garden setup] → [1.Auto mode] → [1.Mowing start points] → [1.Point 1] to [5.Point 5]

Point 1: ____ - ____ Point 2: ____ - ____ Point 3: ____ - ____
Point 4: ____ - ____ Point 5: ____ - ____

Narrow passage:

 **Home screen** → [2.Garden setup] → [1.Auto mode] → [6.Narrow passage]

1: Direction: CW / ACW From: ____ m To: ____ m
2: Direction: CW / ACW From: ____ m To: ____ m
3: Direction: CW / ACW From: ____ m To: ____ m
4: Direction: CW / ACW From: ____ m To: ____ m

Passage width (Homing):

 **Home screen** → [2.Garden setup] → [4.Homing setup] → [1.Passage width]

MIN: ____ MAX: ____

Useful features information (pages 37, 42, 43)

 **Home screen** → [1.Work timer] → [4.Quiet timer]

Quiet timer: ON / OFF From __ : __ to __ : __

 **Home screen** → [2.Garden setup] → [1.Auto mode]

Edge cutting: ON / OFF
Spiral cutting: ON / OFF

Dealer setting back up:

With Dr.H or Mii-monitor: YES / NO

*The following screen is for dealers only.

 **Home screen** → [5.System settings] → [6.dealer settings]

On Lawnmower Display: YES / NO

Your dealer's contact information is below:

Dealer:

Tel:

Mail:

Your Mii-monitor personal id:

QUICK GUIDE

Fundamentals

Turning on / off the power
(☞ page 11, 67)

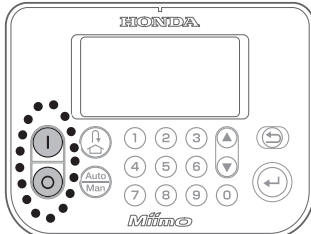

Sending back home
(☞ page 11)

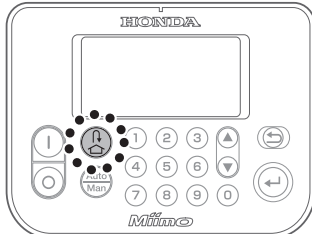

Stopping the lawnmower
(☞ page 10)

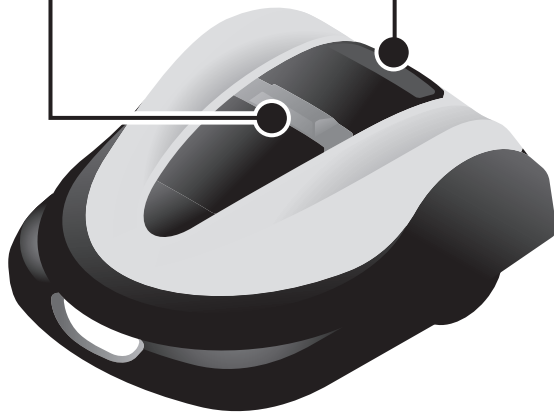

Mii-monitor

Refer to the Mii-monitor Operation Guide.



Operate within a distance of about 3 m from the lawnmower.



Daily use

1 Menu settings



Configure the operation mode, timer, and other settings.

- Work settings for the garden
 - Mowing start point settings (☞ page 35)
 - Narrow passage settings (☞ page 44)
 - Mowing pattern settings (☞ page 45)
- Timer settings (☞ page 34)
- Useful settings (☞ page 36, 37, 45)
- Operation checks (☞ page 52)
- Setup wizard (☞ page 17)
- Mii-monitor (☞ page 62)

2 Check the garden

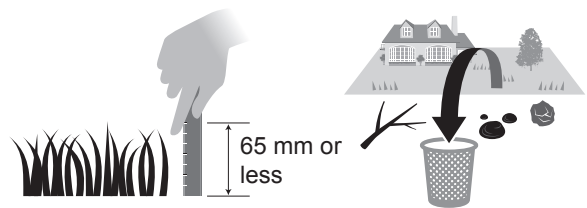

Maintain the area before the lawnmower starts mowing.

- Checking the garden (☞ page 66)
- Removing foreign objects from the area (☞ page 66)

Technical tips

Mowing mode

You can select from 2 modes of operation (available in “Menu Settings”).

- **Auto mode** (☞ page 38)

The lawnmower automatically mows according to inputted time and garden settings.

- **Manual mode** (☞ page 45)

Start mowing anytime without timer settings.

Cleaning the lawnmower (☞ page 80)

Clean dirt and grass off of the lawnmower using a plastic brush and cloth.

Remove dirt and grass from the following areas:

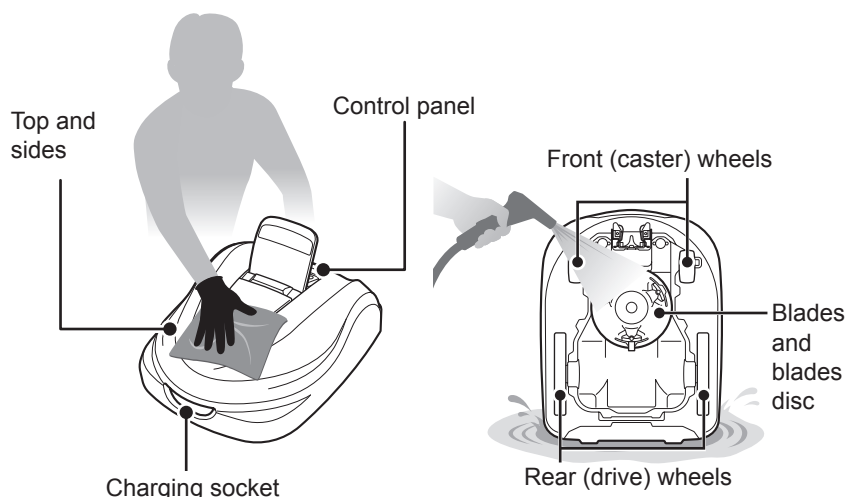

NOTE:

- Never use a scraper. It may cause damage (tears, scratches, etc) to the rubber boots on the underside of the lawnmower.



- Do not wash the docking station with water. The docking station may be damaged.



3 Paused

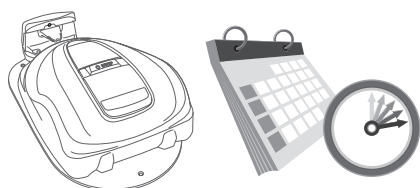

Put on “Paused” state for work so you can start operation at your desired time.

- Setting the height of the blades (☞ page 70)
- Checking the “Paused” state (☞ page 67)
- Checking the docking station connections (☞ page 66)

4 Weekly check



Regularly check the lawnmower for assurance.

- Checking the standby status (☞ page 67)
- Checking the docking station connections (☞ page 82)
- Blade conditions (☞ page 86)
- Checking the parts (☞ page 79, 81)

5 Storage



Store properly for next use.

- Cleaning and replacing the blades (☞ page 86)
- Cleaning the lawnmower (☞ page 80)
- Cleaning the docking station (☞ page 81)
- Disconnecting the AC adapter and power cable (☞ page 66)

MEMO



HONDA
The Power of Dreams